

X1-4K Pro/X2-4K Pro

Projector User Guide

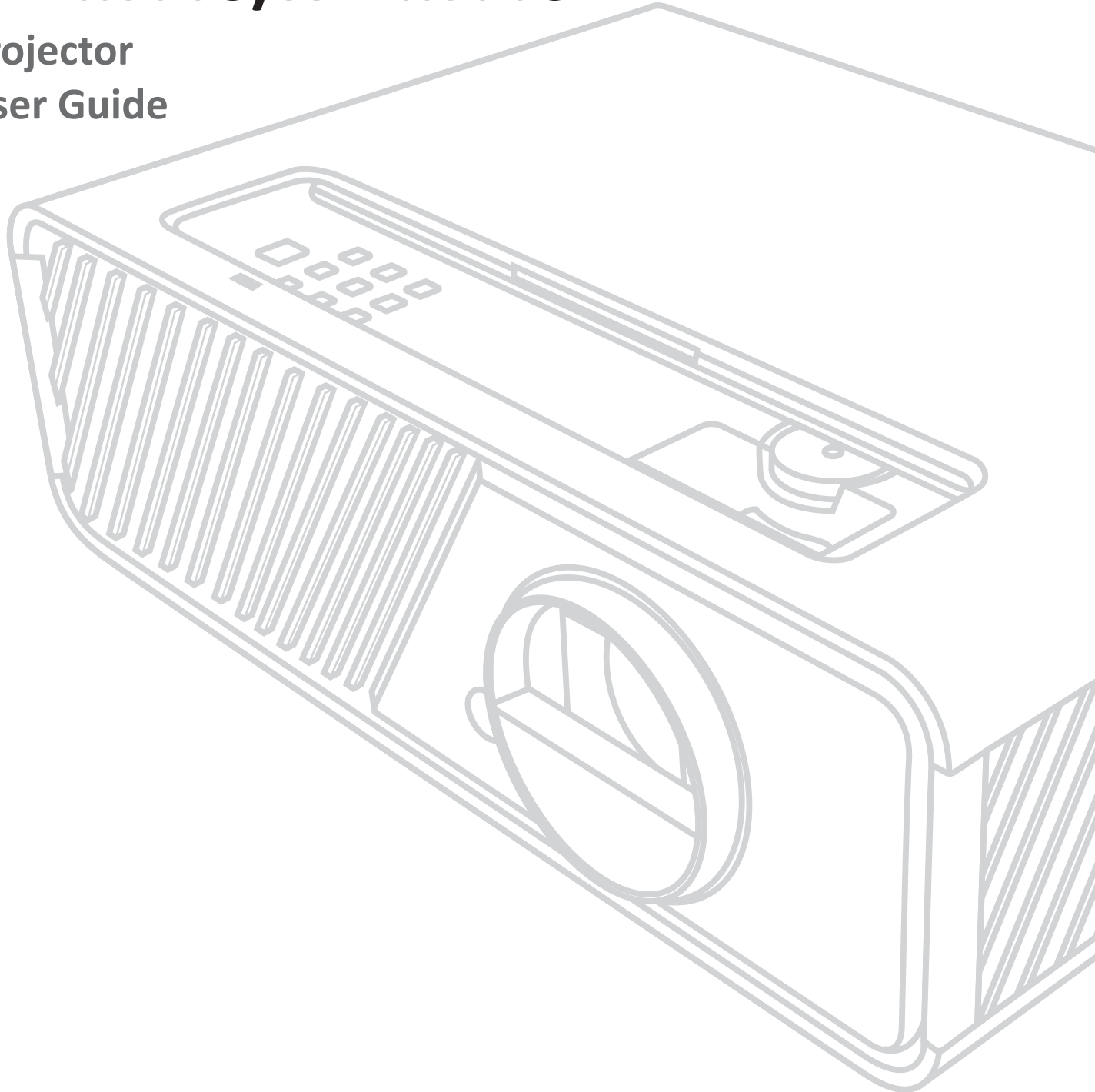

IMPORTANT: Please read this User Guide to obtain important information on installing and using your product in a safe manner, as well as registering your product for future service. Warranty information contained in this User Guide will describe your limited coverage from ViewSonic Corporation, which is also found on our web site at <http://www.viewsonic.com> in English, or in specific languages using the Regional selection box in the upper right corner of our website. "Antes de operar su equipo lea cuidadosamente las instrucciones en este manual"

Model No.: VS20074 / VS20075
Model Name: X1-4K Pro/X2-4K Pro

Contents

| | |
|--|-----------|
| Introduction | 5 |
| Package Contents | 5 |
| Product Overview | 6 |
| Projector | 6 |
| Controls and Functions | 6 |
| Connection Ports..... | 7 |
| Remote Control | 8 |
| Controls and Functions | 8 |
| Remote Control Effective Range | 9 |
| Replacing the Remote Control Batteries | 10 |
| Initial Setup..... | 11 |
| Choosing a Location | 11 |
| Projection Dimensions | 12 |
| 16:9 Image on a 16:9 Screen | 12 |
| X1-4K Pro..... | 12 |
| X2-4K Pro..... | 13 |
| 16:9 Image on a 4:3 Screen | 13 |
| X1-4K Pro..... | 13 |
| X2-4K Pro..... | 14 |
| Mounting the Projector | 15 |
| Preventing Unauthorized Use | 16 |
| Using the Security Slot | 16 |
| Using the Password Function..... | 17 |
| Setting a Password | 17 |
| Changing the Password | 18 |
| Disabling the Password Function | 18 |
| Forgetting the Password | 19 |
| Password Recall Procedure | 19 |
| Locking the Control Keys | 20 |
| Making Connections..... | 21 |
| Connecting to Power | 21 |
| Connecting to Video/Computer Sources | 22 |
| HDMI Connection..... | 22 |
| USB C Connection..... | 22 |
| Connecting to Audio | 22 |

| | |
|--|-----------|
| Operation..... | 24 |
| Turning the Projector On/Off | 24 |
| Starting Up the Projector | 24 |
| First Time Activation | 24 |
| Shutting Down the Projector..... | 26 |
| Selecting an Input Source | 27 |
| Adjusting the Projected Image | 28 |
| Adjusting the Projector's Height and Projection Angle..... | 28 |
| Fine-Tuning the Image Size and Clarity | 28 |
| Correcting Keystone | 29 |
| Adjusting 4 corners | 30 |
| Hiding the Image | 30 |
| Menu Functions | 31 |
| General On-Screen Display (OSD) Menu Operation | 31 |
| On-Screen Display (OSD) Menu Tree | 32 |
| DISPLAY Menu | 38 |
| IMAGE Menu | 41 |
| POWER MANAGEMENT Menu | 44 |
| BASIC Menu | 46 |
| ADVANCED Menu | 49 |
| SYSTEM Menu | 53 |
| INFORMATION Menu | 55 |
| Smart System | 56 |
| Home Screen | 56 |
| Connect Bluetooth Speaker | 57 |
| Cast | 57 |
| Screen Mirroring | 57 |
| Check for system updates | 58 |

| | |
|--|-----------|
| Appendix | 59 |
| Specifications | 59 |
| Projector Dimensions | 60 |
| Timing Chart | 61 |
| Troubleshooting | 63 |
| Common Problems | 63 |
| LED Indicator | 64 |
| Maintenance | 65 |
| General Precautions | 65 |
| Cleaning the Lens | 65 |
| Cleaning the Case | 65 |
| Storing the Projector | 65 |
| Disclaimer | 65 |
| Regulatory and Service Information | 66 |
| Compliance Information | 66 |
| FCC Compliance Statement | 66 |
| Industry Canada Statement | 66 |
| CE Conformity for European Countries | 67 |
| Declaration of RoHS2 Compliance..... | 68 |
| Indian Restriction of Hazardous Substances | 69 |
| Product Disposal at End of Product Life | 69 |
| Copyright Information | 70 |
| Customer Service | 71 |
| Limited Warranty | 72 |
| Mexico Limited Warranty | 75 |

Introduction

Package Contents

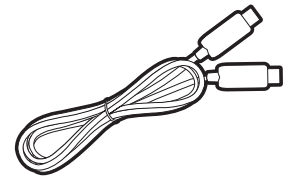
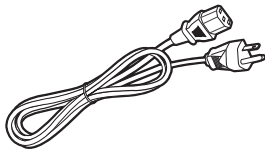
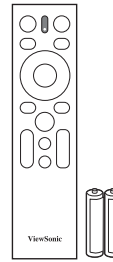
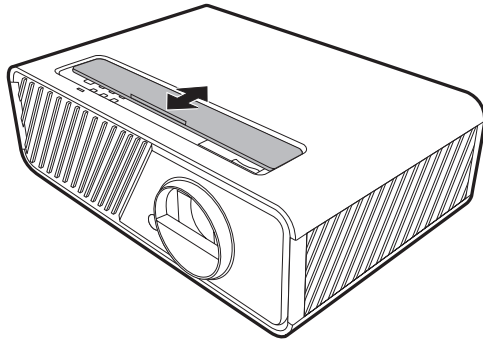

NOTE: The power cord and video cables included in your package may vary depending on your country. Please contact your local reseller for more information.

Product Overview

Projector

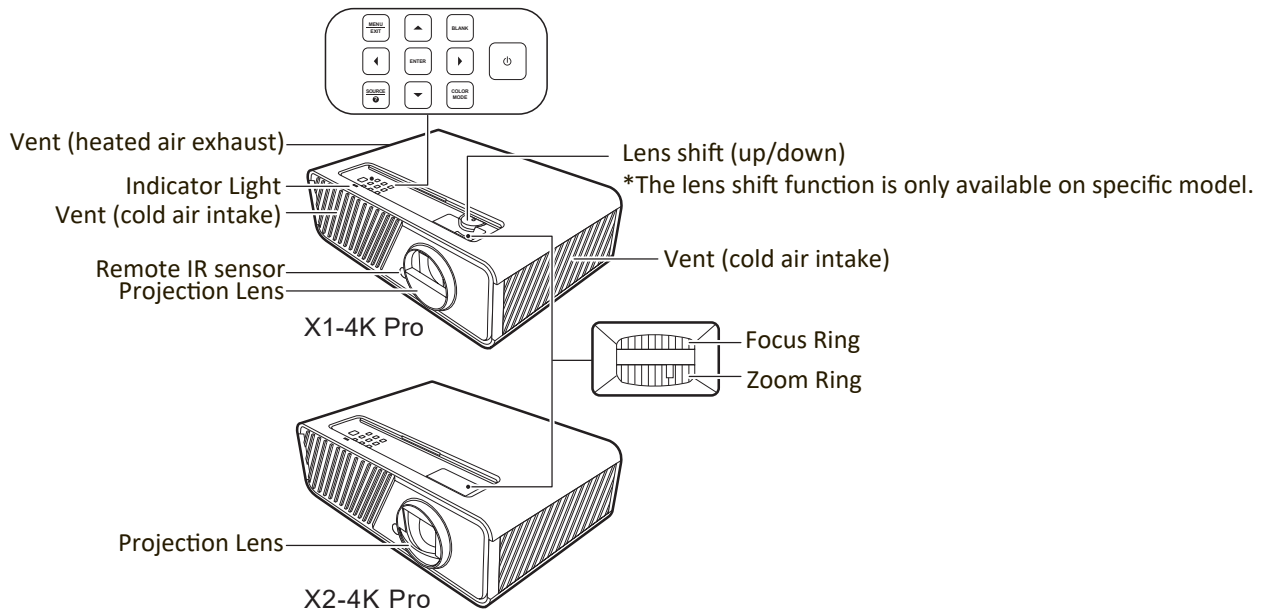

Controls and Functions

| Key | Description |
|---------------------------------|--|
| [⏻] Power | Toggles the projector between standby mode and Power On. |
| MENU | <ul style="list-style-type: none"> Turns on or off the On-Screen Display (OSD) Menu. |
| EXIT | <ul style="list-style-type: none"> Goes back to previous OSD menu, exits and saves menu settings. |
| [◀/▶/▲/▼] Left/Right/Up/Down | <p>When the input source is SMART SYSTEM</p> <p>Moves through the menu items or toggle through the available options.</p> <p>When the input source is not SMART SYSTEM</p> <ul style="list-style-type: none"> Manually corrects distorted images resulting from an angled projection. Selects the desired menu items and makes adjustments when the On-Screen Display (OSD) Menu is activated. |
| SOURCE | <ul style="list-style-type: none"> Displays the input source selection bar. Displays the HELP menu by a long press for 3 seconds. |
| BLANK | Hides the screen picture. |
| ENTER | <p>When the input source is SMART SYSTEM</p> <p>Confirms the selected menu item.</p> <p>When the input source is not SMART SYSTEM</p> <ul style="list-style-type: none"> Displays the Corner Adj. menu. Enacts the selected On-Screen Display (OSD) Menu item when the OSD Menu is activated. |
| COLOR MODE | Displays the color mode selection bar. |

Connection Ports

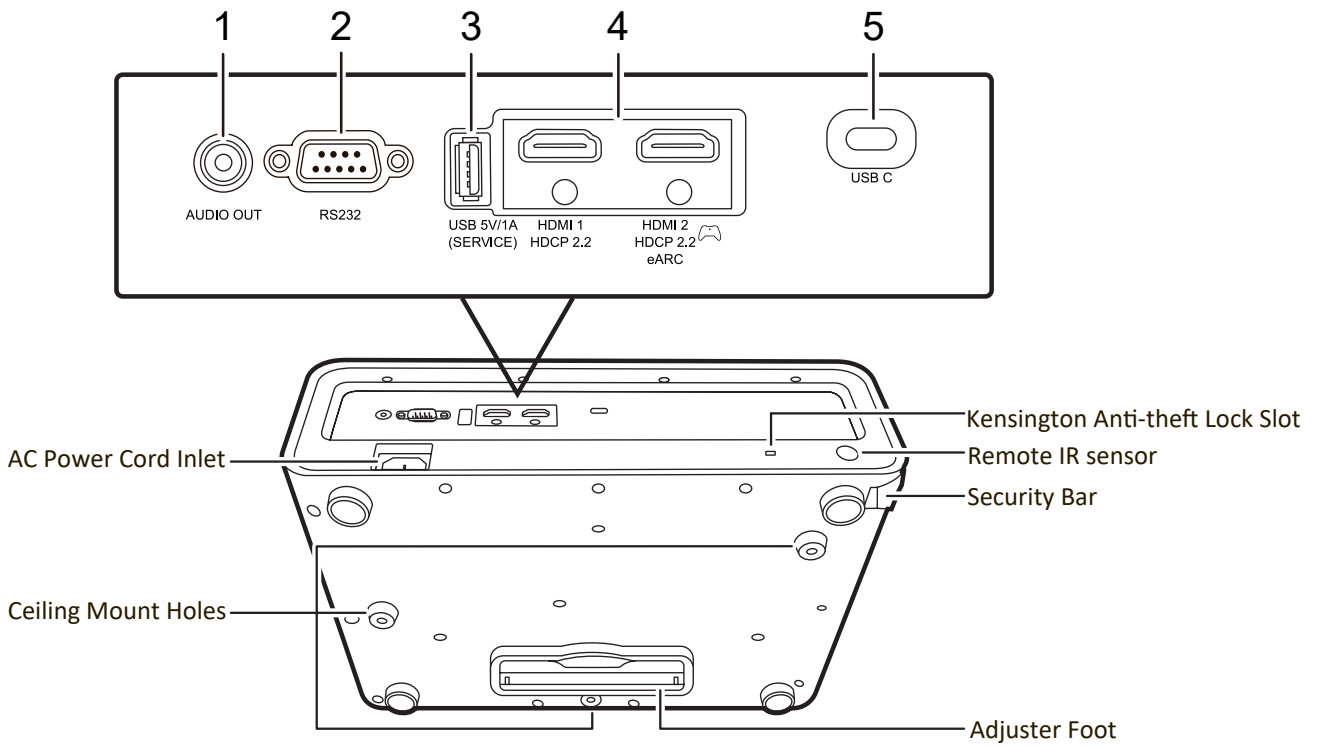

| Port | Description |
|-------------------------|---|
| [1] AUDIO OUT | Audio signal output socket. |
| [2] RS-232 | RS-232 control port. |
| [3] USB 5V/1A (SERVICE) | For power supply and service. NOTE: Apple products are not supported. |
| [4] HDMI 1, HDMI 2 | HDMI ports. |
| [5] USB C | USB Type-C port. |

Remote Control

Controls and Functions

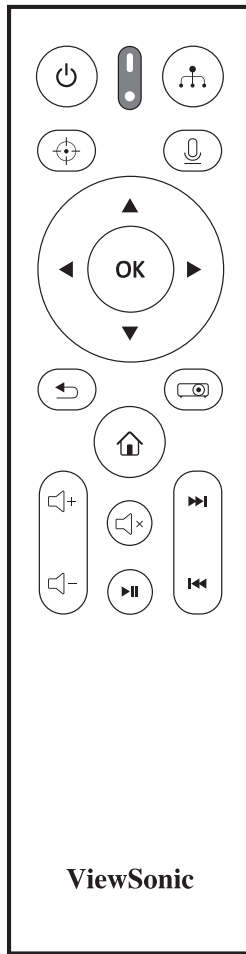

| Button | Description |
|---------------------------------------|--|
| Power | Toggles between standby mode and Power On. |
| | Not available. |
| | Displays the source selection bar. |
| | Activates the voice function. This function is only available after the bluetooth remote control was paired. |
| ◀ Left/ ▶ Right ▲ Up/ ▼ Down | Selects the desired menu items and makes adjustments. |
| OK | Confirms the selected menu item. |
| | Turns on/off the On-Screen Display (OSD) Menu or goes back to previous OSD menu. |

| Button | Description |
|--------|--|
| | Returns to the previous menu, main settings menu or exit the app. |
| | <ul style="list-style-type: none"> Goes to the homepage of the SMART SYSTEM. Changes to the SMART SYSTEM source. |
| | Increases the projector volume. |
| | Decreases the projector volume. |
| | Mutes or unmutes the projector volume. |
| | Only available under the SMART SYSTEM.* |
| | |
| | |

*These buttons behave differently when using different streaming applications as shown in the table below.

| Button App | | | |
|---------------|----------------------------|-------------------------------|------------------------------|
| Netflix | Plays or pauses the video. | Advances the video by 10 sec. | Rewinds the video by 10 sec. |
| Youtube | Pauses the video. | Goes to the next video. | Goes to the previous video |
| Disney+ | | | No response. |
| Prime Video | | Fast forwards the video. | Rewinds the video. |

Remote Control Effective Range

To ensure proper function of the remote control follow the steps below:

1. The remote control must be held at an angle within 30° perpendicular to the projector's IR remote control sensor(s).
2. The distance between the remote control and the sensor(s) should not exceed 8 m (26 ft.)

NOTE: Refer to the illustration for the location of the infrared (IR) remote control sensor(s).

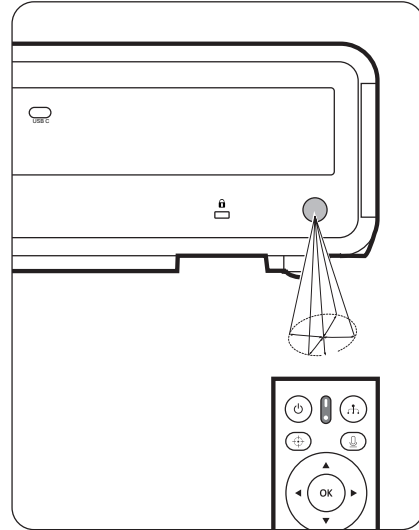
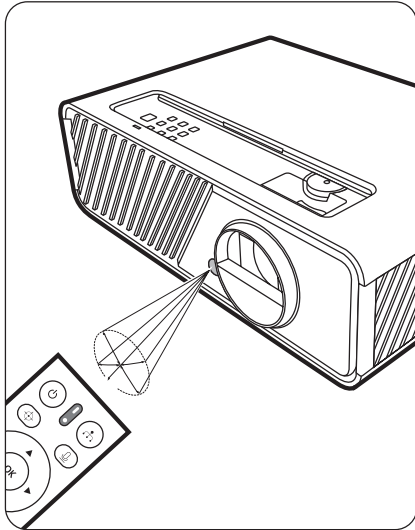

Replacing the Remote Control Batteries

1. Remove the battery cover from the rear of the remote control by pressing the finger grip and sliding it down.
2. Remove any existing batteries (if necessary) and install two AAA batteries.

NOTE: Observe the battery's polarities as indicated.

3. Replace the battery cover by aligning it with the base and pushing it back into position.

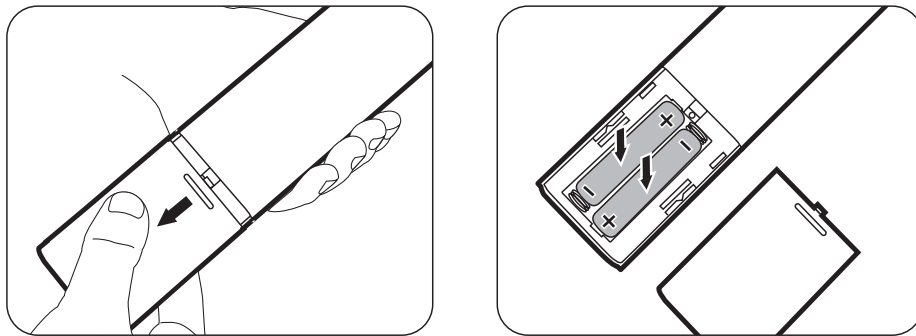

NOTE:

- Avoid leaving the remote control and batteries in excessive heat or a humid environment.
- Replace only with the same or equivalent type recommended by the battery manufacturer.
- Dispose of the used batteries according to the manufacturer's instructions and local environment regulations for your region.
- If the batteries are drained or if you will not be using the remote control for an extended period of time, remove the batteries to avoid damage to the remote control.

Initial Setup

This section provides detailed instructions for setting up your projector.

Choosing a Location

Personal preference and room layout will decide the installation location. Consider the following:

- Size and Position of your screen.
- Location of a suitable power outlet.
- Location and Distance between the projector and other equipment.

The projector is designed to be installed in one of the following locations:

1. Front

The projector is placed near the floor in front of the screen.

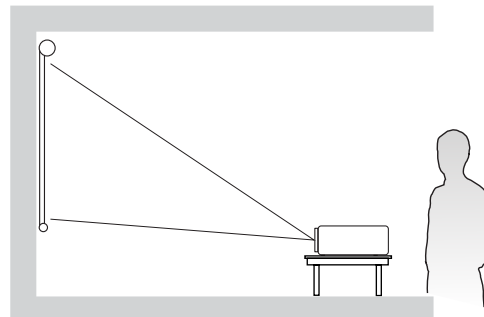

2. Front Ceiling

The projector is suspended upside-down from the ceiling in front of the screen.

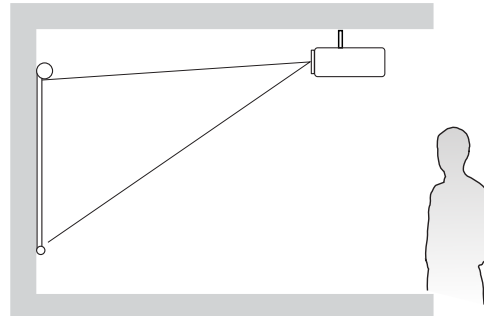

3. Rear Ceiling

The projector is suspended upside-down from the ceiling behind the screen.

NOTE: A special rear projection screen is required.

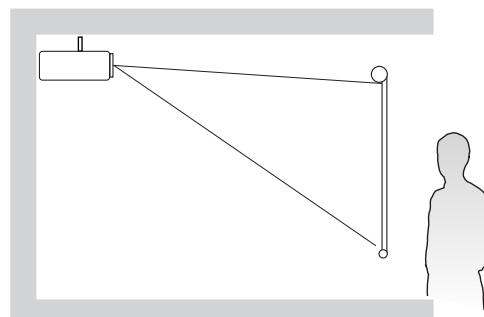

4. Rear

The projector is placed near the floor behind the screen.

NOTE: A special rear projection screen is required.

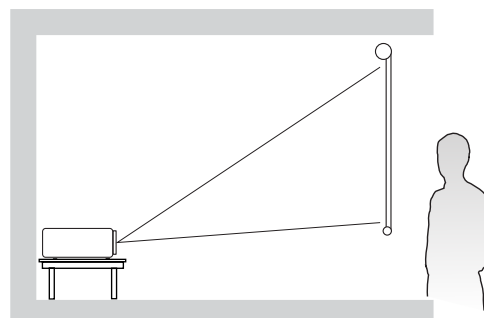

Projection Dimensions

NOTE: See “Specifications” on page 59 for the native display resolution of this projector.

- 16:9 Image on a 16:9 Screen

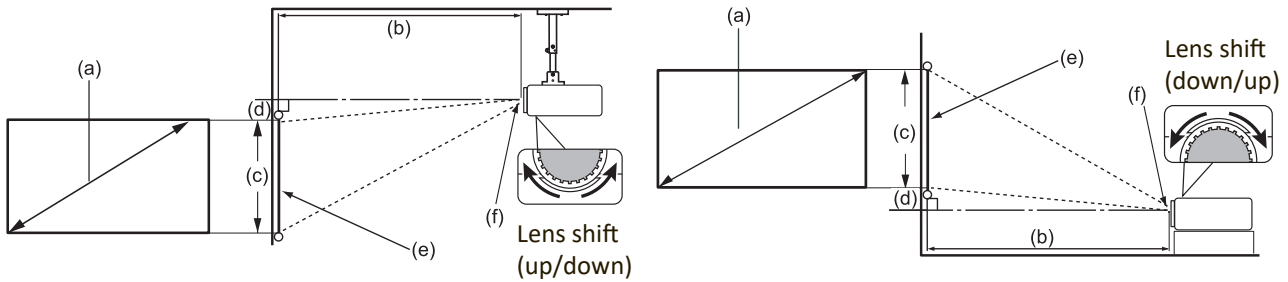

- 16:9 Image on a 4:3 Screen

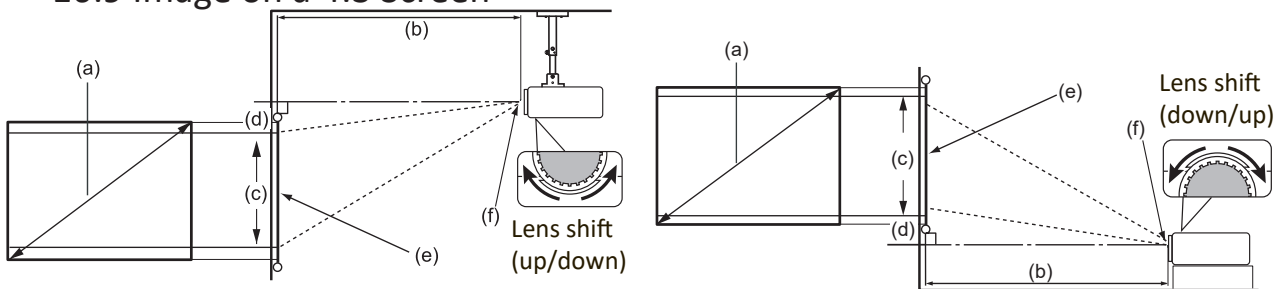

NOTE: (e) = Screen

(f) = Center of Lens

The Lens shift function is only available on X1-4K Pro.

- 16:9 Image on a 16:9 Screen

X1-4K Pro

| (a) Screen Size | | (b) Projection Distance | | | | (c) Image Height | | (d) Vertical Offset | | | |
|-----------------|------|-------------------------|------|------|------|------------------|------|---------------------|----|------|-----|
| inch | mm | inch | mm | inch | mm | inch | mm | inch | mm | inch | mm |
| 60 | 1524 | 60 | 1522 | 78 | 1979 | 29 | 747 | 1.5 | 37 | 4.4 | 112 |
| 70 | 1778 | 70 | 1776 | 91 | 2309 | 34 | 872 | 1.7 | 44 | 5.1 | 131 |
| 80 | 2032 | 80 | 2029 | 104 | 2638 | 39 | 996 | 2.0 | 50 | 5.9 | 149 |
| 90 | 2286 | 90 | 2283 | 117 | 2968 | 44 | 1121 | 2.2 | 56 | 6.6 | 168 |
| 100 | 2540 | 100 | 2537 | 130 | 3298 | 49 | 1245 | 2.5 | 62 | 7.4 | 187 |
| 110 | 2794 | 110 | 2791 | 143 | 3628 | 54 | 1370 | 2.7 | 68 | 8.1 | 205 |
| 120 | 3048 | 120 | 3044 | 156 | 3957 | 59 | 1494 | 2.9 | 75 | 8.8 | 224 |
| 130 | 3302 | 130 | 3298 | 169 | 4287 | 64 | 1619 | 3.2 | 81 | 9.6 | 243 |
| 140 | 3556 | 140 | 3552 | 182 | 4617 | 69 | 1743 | 3.4 | 87 | 10.3 | 262 |
| 150 | 3810 | 150 | 3805 | 195 | 4947 | 74 | 1868 | 3.7 | 93 | 11.0 | 280 |

X2-4K Pro

| (a) Screen Size | | (b) Projection Distance | | | | (c) Image Height | | (d) Vertical Offset | |
|-----------------|------|-------------------------|------|---------|------|------------------|------|---------------------|----|
| | | minimum | | maximum | | | | minimum | |
| inch | mm | inch | mm | inch | mm | inch | mm | inch | mm |
| 60 | 1524 | 36 | 909 | 43 | 1091 | 29 | 747 | 0.7 | 19 |
| 70 | 1778 | 42 | 1061 | 50 | 1273 | 34 | 872 | 0.9 | 22 |
| 80 | 2032 | 48 | 1213 | 57 | 1455 | 39 | 996 | 1.0 | 25 |
| 90 | 2286 | 54 | 1364 | 64 | 1637 | 44 | 1121 | 1.1 | 28 |
| 100 | 2540 | 60 | 1516 | 72 | 1819 | 49 | 1245 | 1.2 | 31 |
| 110 | 2794 | 66 | 1667 | 79 | 2001 | 54 | 1370 | 1.3 | 34 |
| 120 | 3048 | 72 | 1819 | 86 | 2183 | 59 | 1494 | 1.5 | 37 |

- 16:9 Image on a 4:3 Screen

X1-4K Pro

| (a) Screen Size | | (b) Projection Distance | | | | (c) Image Height | | (d) Vertical Offset | | | |
|-----------------|------|-------------------------|------|---------|------|------------------|------|---------------------|----|---------|-----|
| | | minimum | | maximum | | | | minimum | | maximum | |
| inch | mm | inch | mm | inch | mm | inch | mm | inch | mm | inch | mm |
| 60 | 1524 | 55 | 1397 | 72 | 1816 | 27 | 686 | 1 | 34 | 4 | 103 |
| 70 | 1778 | 64 | 1630 | 83 | 2119 | 32 | 800 | 2 | 40 | 5 | 120 |
| 80 | 2032 | 73 | 1863 | 95 | 2422 | 36 | 914 | 2 | 46 | 5 | 137 |
| 90 | 2286 | 83 | 2096 | 107 | 2724 | 41 | 1029 | 2 | 51 | 6 | 154 |
| 100 | 2540 | 92 | 2329 | 119 | 3027 | 45 | 1143 | 2 | 57 | 7 | 171 |
| 110 | 2794 | 101 | 2561 | 131 | 3330 | 50 | 1257 | 2 | 63 | 7 | 189 |
| 120 | 3048 | 110 | 2794 | 143 | 3632 | 54 | 1372 | 3 | 69 | 8 | 206 |
| 130 | 3302 | 119 | 3027 | 155 | 3935 | 59 | 1486 | 3 | 74 | 9 | 223 |
| 140 | 3556 | 128 | 3260 | 167 | 4238 | 63 | 1600 | 3 | 80 | 9 | 240 |
| 150 | 3810 | 138 | 3493 | 179 | 4541 | 68 | 1715 | 3 | 86 | 10 | 257 |

X2-4K Pro

| (a) Screen Size | | (b) Projection Distance | | | | (c) Image Height | | (d) Vertical Offset | |
|-----------------|------|-------------------------|------|---------|------|------------------|------|---------------------|----|
| | | minimum | | maximum | | | | minimum | |
| inch | mm | inch | mm | inch | mm | inch | mm | inch | mm |
| 60 | 1524 | 33 | 835 | 39 | 1002 | 27 | 686 | 1 | 17 |
| 70 | 1778 | 38 | 974 | 46 | 1169 | 32 | 800 | 1 | 20 |
| 80 | 2032 | 44 | 1113 | 53 | 1336 | 36 | 914 | 1 | 23 |
| 90 | 2286 | 49 | 1252 | 59 | 1503 | 41 | 1029 | 1 | 26 |
| 100 | 2540 | 55 | 1391 | 66 | 1670 | 45 | 1143 | 1 | 29 |
| 110 | 2794 | 60 | 1530 | 72 | 1837 | 50 | 1257 | 1 | 31 |
| 120 | 3048 | 66 | 1670 | 79 | 2003 | 54 | 1372 | 1 | 34 |

NOTE: It is recommended that if you intend to permanently install the projector, please physically test the projection size and distance using the actual projector in situ before you permanently install it.

Mounting the Projector

NOTE: If you buy a third-party mount, please use the correct screw size. Screw size can vary depending on the thickness of the mounting plate.

1. To ensure the most secure installation, please use a ViewSonic® wall or ceiling mount.
2. Ensure the screws used to attach a mount to the projector meet the following specifications:
 - Screw type: M4 x 8
 - Maximum Screw length: 8 mm

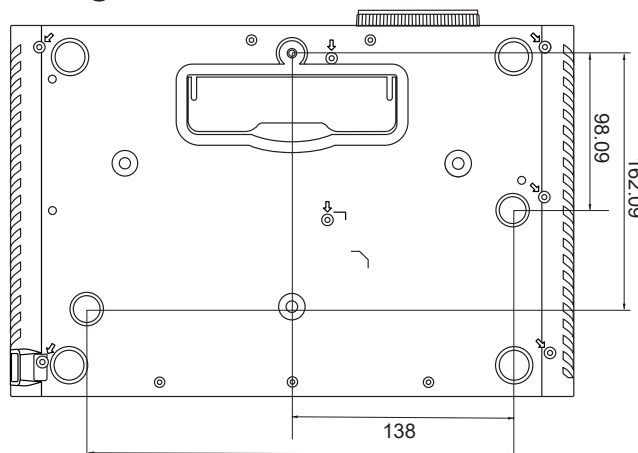

NOTE:

- Avoid installing the projector near a heat source.
- Keep at least a 10 cm gap between the ceiling and the bottom of the projector.

Preventing Unauthorized Use

The projector has several built-in security features to prevent theft, access, or accidental setting changes.

Using the Security Slot

To help prevent the projector from being stolen, use a security slot locking device to secure the projector to a fixed object.

Below is an example of setting up a security slot locking device:

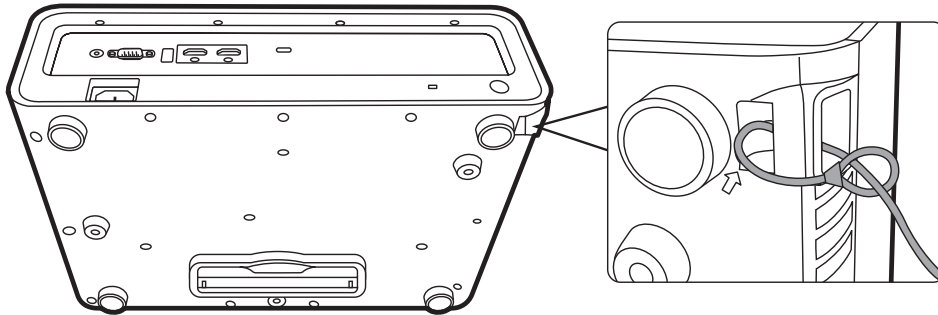

NOTE: The security slot can also be used as a safety anchor if the projector is mounted to the ceiling.

Using the Password Function

To help prevent unauthorized access or use, the projector offers a password security option. The password can be set through the On-Screen Display (OSD) Menu.

NOTE: Make note of your password, and keep it in a safe place.

Setting a Password



1. Press **MENU** or  to open the OSD Menu and go to: **SYSTEM > Security Settings** and press **ENTER/OK**.
2. Highlight **Power On Lock** and select **On** by pressing **◀/▶**.
3. As pictured to the right, the four arrow keys (**▲**, **▶**, **▼**, **◀**) represent 4 digits (1, 2, 3, 4). Press the arrow keys to enter a six digit password.



4. Confirm the new password by re-entering the new password. Once the password is set, the OSD Menu will return to the Security Settings page.
5. Press **EXIT** or  to leave the OSD Menu.



NOTE: Once set, the correct password must be entered every time the projector is started.

Changing the Password

1. Press **MENU** or  to open the OSD Menu and go to: **SYSTEM > Security Settings > Change Password**.
2. Press **ENTER/OK**, the message, 'INPUT CURRENT PASSWORD' will appear.
3. Enter the old password.
 - ^m If the password is correct, the message, 'INPUT NEW PASSWORD' will appear.
 - ^m If the password is incorrect, a password error message will appear for 5 seconds followed by the message, 'INPUT CURRENT PASSWORD'. You can try again or press **EXIT** or  to cancel.
4. Enter a new password.
5. Confirm the new password by re-entering the new password.
6. To leave the OSD Menu, press **EXIT** or .

NOTE: The digits being input will display as asterisks(*).

Disabling the Password Function

1. Press **MENU** or  to open the OSD Menu and go to: **SYSTEM > Security Settings > Power On Lock**.
2. Press **◀/▶** to select Off.
3. The message, "Input Password" will appear. Enter the current password.
 - ^m If the password is correct, the OSD Menu returns to the Password page with "Off" shown in the row of Power On Lock.
 - ^m If the password is incorrect, a password error message will appear for 5 seconds followed by the message, 'INPUT CURRENT PASSWORD'. You can try again or press **EXIT** or  to cancel.

NOTE: Please keep the old password, as you will need it to reactivate the password function.

Forgetting the Password

If the password function is activated, you will be asked to enter the six-digit password every time you turn on the projector. If you enter the wrong password, the password error message, as pictured to the right, will appear for 5 seconds, and the message 'INPUT PASSWORD' follows.

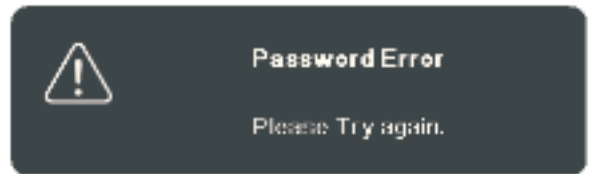

You can retry or if you do not remember, you can use the "Password Recall Procedure".

NOTE: If you enter an incorrect password 5 times in succession, the projector will automatically shut down for a short time.

Password Recall Procedure

1. When the message 'INPUT CURRENT PASSWORD' appears, press and hold **ENTER/OK** for 3 seconds. The projector will display a coded number on the screen.
2. Write down the number and turn off your projector.
3. Seek help from the local service center to decode the number. You may be required to provide proof of purchase documentation to verify that you are an authorized user of the projector.

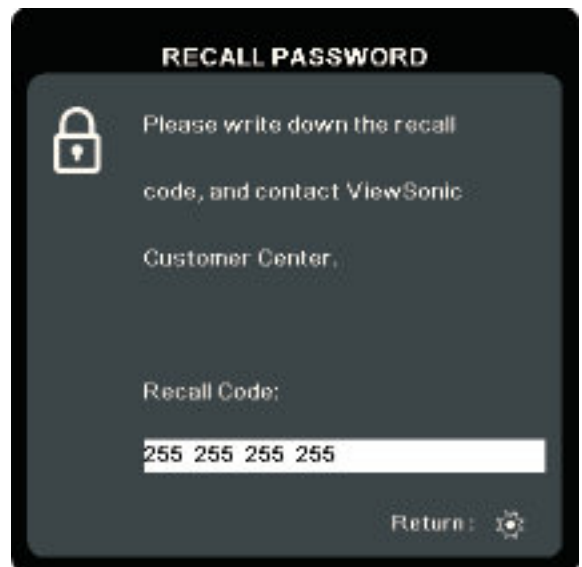

Locking the Control Keys

With the control keys on the projector locked, you can prevent your settings from being changed accidentally (by children, for example).

NOTE: When the **Panel Key Lock** is On, no control keys on the projector will operate except **Power**.

1. Press MENU or  to open the OSD Menu and go to: **SYSTEM > Panel Key Lock**.
2. Press ▲/▼ to select **On**.
3. Select Yes and press ENTER/OK to confirm.
4. To release panel key lock, press and hold ► on the projector for 3 seconds.

NOTE: You can also use the remote control to enter the **SYSTEM > Panel Key Lock** menu and select Off.

Making Connections

This section guides you on how to connect the projector with other equipment.

Connecting to Power

1. Connect the power cord to the AC IN jack at the rear of the projector.
2. Plug the power cord into a power outlet.

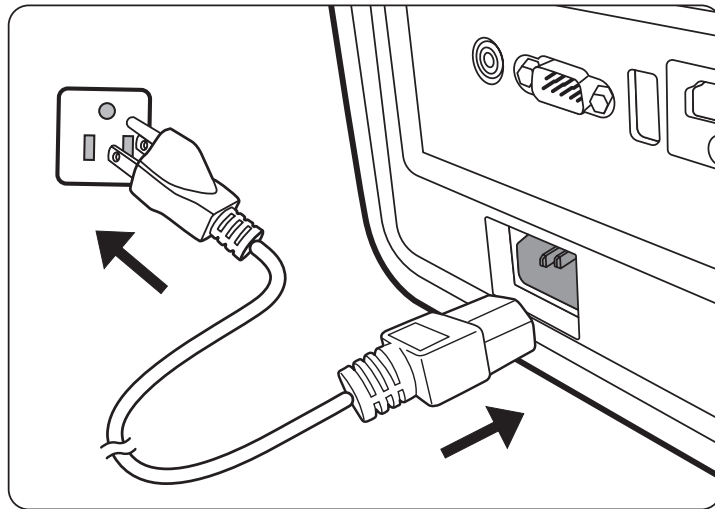

NOTE: When installing the projector, incorporate a readily accessible disconnect device in the fixed wiring, or connect the power plug to an easily accessible outlet near the unit. If a fault should occur during operation of the projector, use the disconnect device to switch off the power supply, or disconnect the power plug.

Connecting to Video/Computer Sources

HDMI Connection

Connect one end of an HDMI cable to the HDMI port of your video/computer device. Then connect the other end of the cable to the **HDMI** port of your projector.

USB C Connection

Connect one end of an USB C cable to the USB C port of your video/computer device. Then connect the other end of the cable to the **USB C** port of your projector.

Connecting to Audio

The projector is equipped with speakers, however, you can also connect external speakers to the **AUDIO OUT** or **HDMI 2** port of the projector. The **HDMI 2** port supports eARC devices.

NOTE: The audio output is controlled by the remote control and the projector's **Volume** and **Mute** settings.

The connection illustrations below are for reference only. The connecting jacks available on the projector vary with each projector model. Some cables may not be included with the projector. They are commercially available from electronics stores.

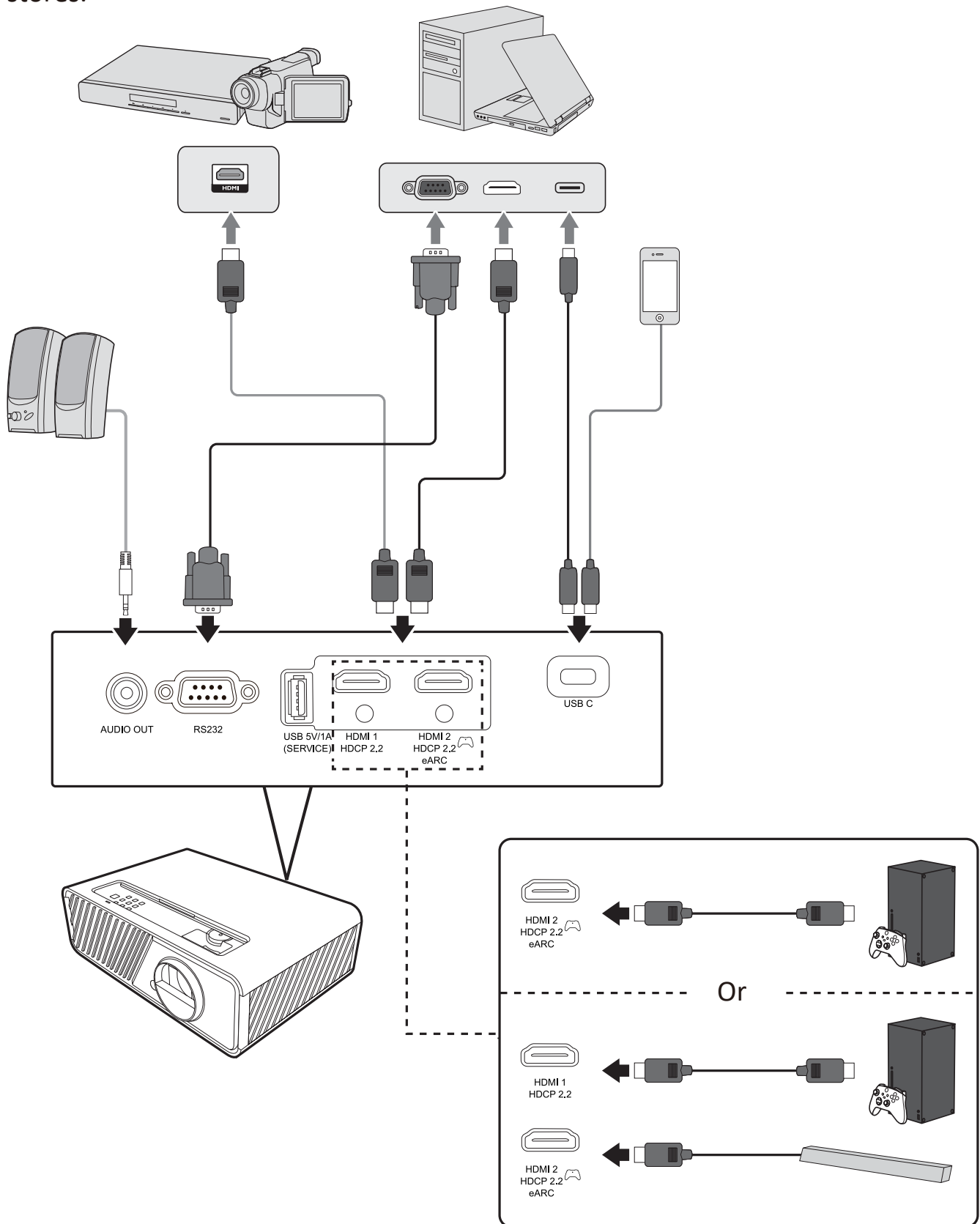

Operation

Turning the Projector On/Off

Starting Up the Projector

1. Press the **Power** button to turn on the projector.
2. The light source will light up, and a “**Power On/Off Ring Tone**” will play.
3. The Power Indicator Light stays green when the projector is On.
4. Turn on all of the connected equipment, i.e. notebook, and the projector will start to search for an input source.

NOTE: If the projector detects an input source, the Source Selection Bar will appear. If an input source is not detected, the message, ‘No Signal’ will appear.

First Time Activation

If the projector is activated for the first time, set the projector position and the OSD language. Then, for the SMART SYSTEM, pair the bluetooth remote control, select the language and country/region, and set up the Google Home app following the on-screen instructions.

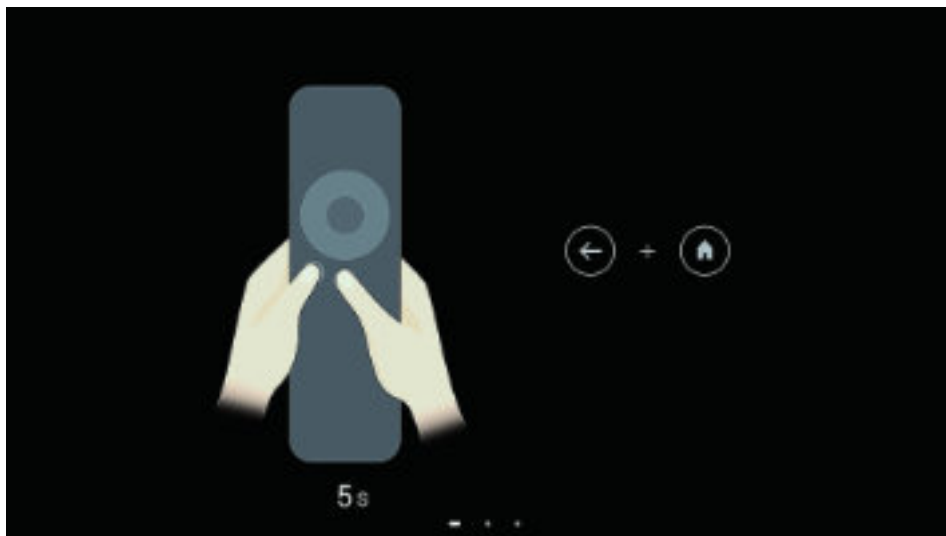

Welcome

English (United States)

Afrikaans

Català

Čeština

Dansk

Deutsch

Select your region or country

Armenia

Argentina

Australia

Austria

Azerbaijan

Bahrain

GoogleTV4274

Set up with the Google Home app

Download and open the Google Home app on your phone to get started

When instructed in the app, scan the QR code



Setup code
KBFAPJFH

Set up on TV instead
May take longer. Requires typing with the remote.

Shutting Down the Projector

1. Press the **Power** button and a confirmation message will appear to prompt you to press the **Power** button a second time. Additionally you can press any other button to cancel.

NOTE: If you do not respond in a few seconds after the first press, the message will disappear.

2. Once the cooling process finishes, a **“Power On/Off Ring Tone”** will play.
3. Disconnect the power cord from the power outlet if the projector will not be used for an extended period of time.

NOTE:

- To protect the light source, the projector will not respond to commands during the cooling process.
- Do not unplug the power cord before the projector completely shuts down.

Selecting an Input Source

The projector can be connected to multiple devices at the same time. However, it can only display one full screen at a time.

If you want the projector to automatically search for the input source, ensure the **Quick Auto Search** function in the **SYSTEM** menu is **On**.

NOTE: If no input source is detected, the projector will go to **SMART SYSTEM**.

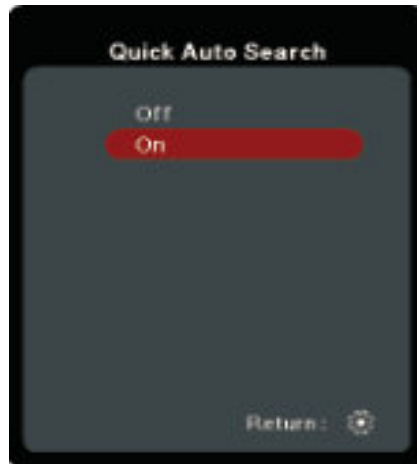

To manually select the input source do the following:

1. Press **SOURCE** or , and a source selection menu will appear.
2. Press **▲/▼** until your desired signal is selected and press **ENTER/OK**.
3. Once detected, the selected source information will be displayed on the screen for a few seconds.

NOTE: If there are multiple devices connected to the projector, repeat steps 1-2 to search for another source.

Adjusting the Projected Image

Adjusting the Projector's Height and Projection Angle

The projector is equipped with one (1) adjuster foot. Adjusting the foot will change the projector's height and the vertical projection angle. Carefully adjust the foot to fine tune the projected image's position.

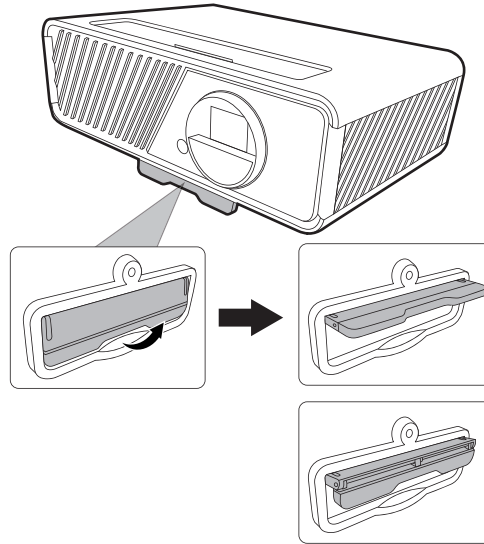

Fine-Tuning the Image Size and Clarity

To adjust the projected image to the size that you need, rotate the Zoom Ring.

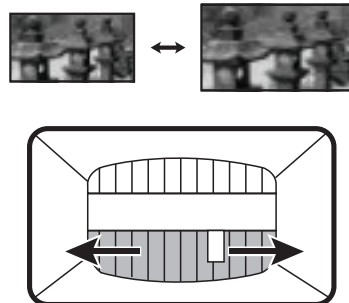

To improve the clarity of the image, rotate the Focus Ring.

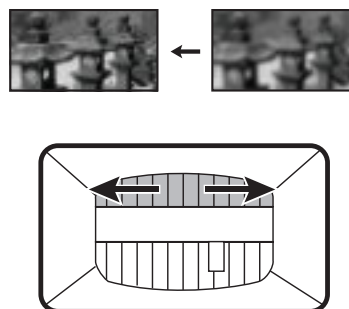

Correcting Keystone

Keystoning refers to the situation where the projected image becomes a trapezoid due to angled projection.

To correct this, besides adjusting the height of the projector, you may also:

1. Use the **◀ Left/ ▶ Right/ ▲ Up/ ▼ Down** keys on the projector or remote control to display the keystone page (when the input source is not **SMART SYSTEM**).
2. After the keystone page is displayed, press **▲ Up** to correct keystone at the top of the image. Press **▼ Down** to correct keystone at the bottom of the image. Press **▶ Right** to correct keystone at the right side of the image. Press **◀ Left** to correct keystone at the left side of the image.

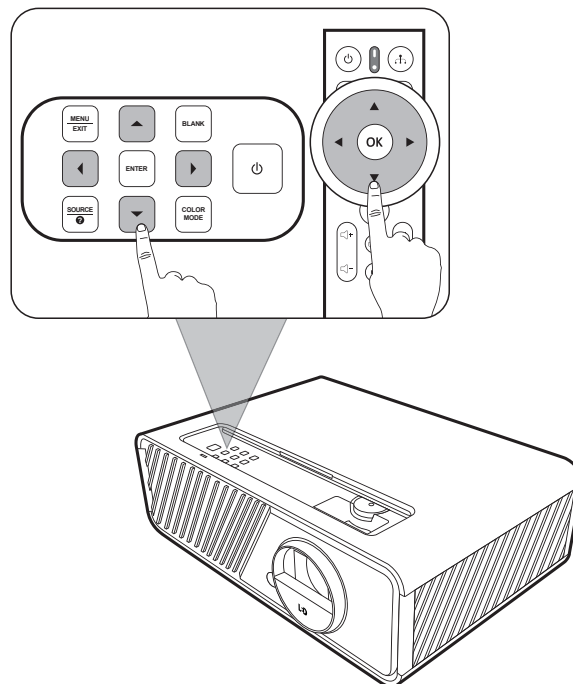
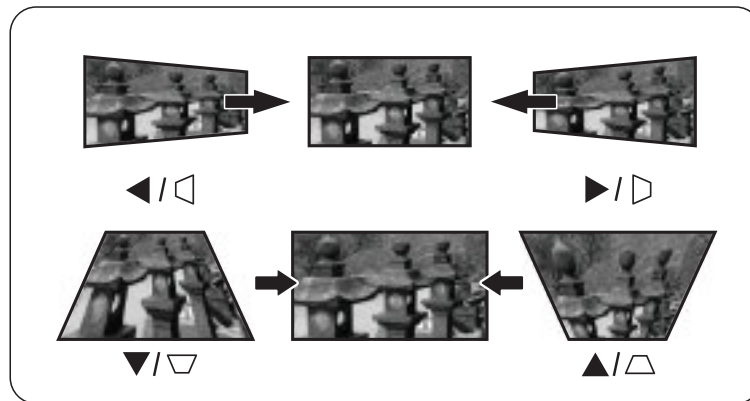

Adjusting 4 corners

You can manually adjust the shape and size of an image that is unevenly rectangular on all sides.

1. To display the **Corner Adj.** page, you can do one of the followings:
 - Press **ENTER/OK** (when the input source is not **SMART SYSTEM**).
 - Open the OSD menu and go to the **DISPLAY > Corner Adj.** menu and press **Enter**. The **Corner Adj.** page is displayed.
2. Use **▲/▼/◀/▶** to select the corner you wish to adjust and press **ENTER/OK**.
3. Use **◀/▶** to select an adjustment method that suits your need and press **ENTER/OK**.
4. As indicated on the screen (**▲/▼** for a 45-degree angle adjustment and **▲/▼/◀/▶** for a 90-degree angle adjustment), press **▲/▼/◀/▶** to adjust its shape and size. You can press **Exit** or **⏏** to go back to a previous step. A long press for 2 seconds on **ENTER/OK** will reset the settings on the corner that you chose.

NOTE:

- Adjusting keystone will reset the **Corner Adj.** settings.
- After the **Corner Adj.** settings have been modified, some aspect ratios or timings are not available. When that happens, reset the settings on all 4 corners.

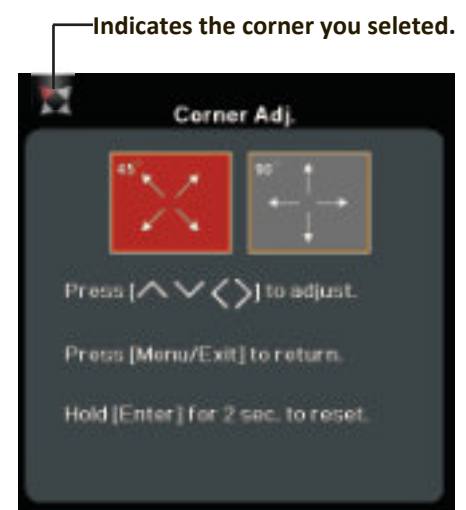
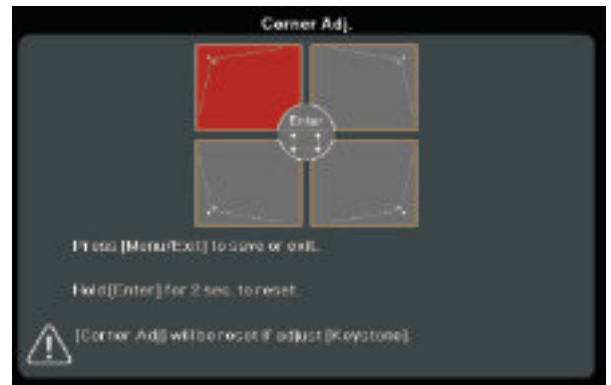

Hiding the Image

In order to draw the audience's full attention to the presenter, you can press **BLANK** on the projector to hide the screen image. Press any key on the projector or remote control to restore the image.

CAUTION: Do not block the projection lens as this could cause the blocking object to become heated and deformed or even cause a fire.

Menu Functions

This section will introduce the On-Screen Display (OSD) Menu and its options.

General On-Screen Display (OSD) Menu Operation

NOTE: The OSD screenshots in this manual are for reference only and may differ from the actual design. Some of the following OSD settings may not be available. Please refer to the actual OSD of your projector.

The projector is equipped with an On-Screen Display (OSD) Menu for making various adjustments. It can be accessed by pressing **MENU** or  on the projector or remote control.

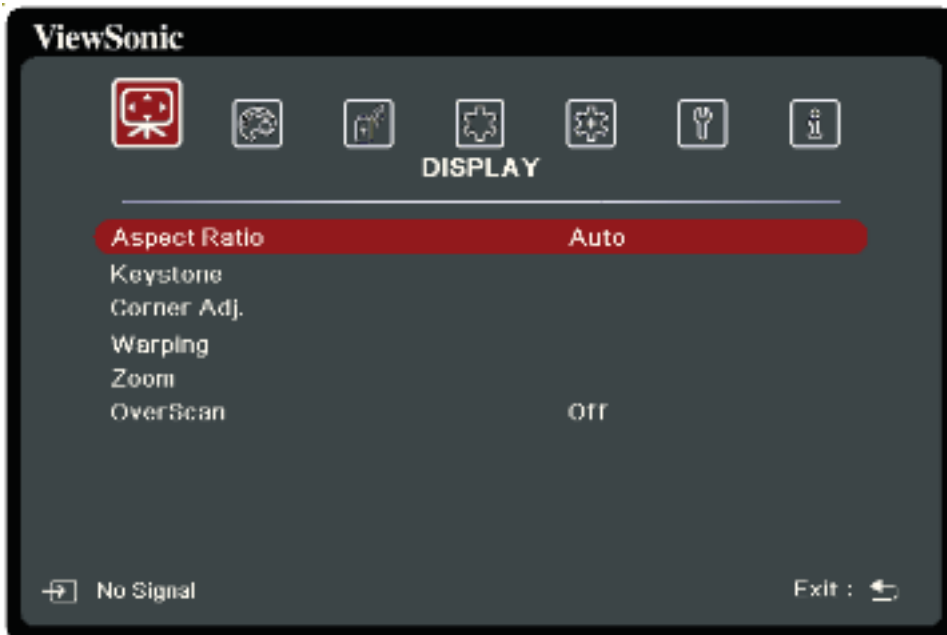

1. Press ◀/▶ to select a main menu. Then press **ENTER/OK** or use ▲/▼ to access the sub-menu list.
2. Press ▲/▼ to select the menu option. Then press **ENTER/OK** to display its sub-menu, or press ◀/▶ to adjust/select the setting.

NOTE: Some sub-menu options may have another sub-menu. To enter the respective sub-menu, press **ENTER/OK**. Use ▲/▼ or ◀/▶ to adjust/select the setting.

On-Screen Display (OSD) Menu Tree

| Main Menu | Sub-menu | Menu Option | |
|-----------|--------------|-----------------|------------|
| DISPLAY | Aspect Ratio | Auto | |
| | | 4:3 | |
| | | 16:9 | |
| | | 16:10 | |
| | | 21:9 | |
| | | 2.35:1 | |
| | | Native | |
| | Keystone | Auto V Keystone | Off/On |
| | | Manual | Vertical |
| | | | Horizontal |
| | | | Rotation |
| | Corner Adj. | Top-Right | |
| | | Top-Left | |
| | | Bottom-Right | |
| | | Bottom-Left | |
| | Warping | Enable | Off/On |
| | | Control Method | OSD |
| | | | RS232 |
| | | Warping Adj. | |
| | | Reset | |
| | Zoom | 0.8X ~2.0X | |
| | OverScan | Off/1/2/3/4/5 | |

| Main Menu | Sub-menu | Menu Option | | |
|-----------|----------------------|-------------------|-------------------------------------|--|
| IMAGE | Color Mode | Brightest | | |
| | | TV | | |
| | | Gaming | | |
| | | Movie | | |
| | | Golf | | |
| | | Low Blue Light | | |
| | | User | | |
| | Brightness | 0~100 | | |
| | Contrast | -50~50 | | |
| | Color Temp. | 9300K/7500K/6500K | | |
| | | Red Gain | 0~100 | |
| | | Green Gain | 0~100 | |
| | | Blue Gain | 0~100 | |
| | | Red Offset | -50~+50 | |
| | | Green Offset | -50~+50 | |
| | | Blue Offset | -50~+50 | |
| | Advanced | Color | -50~50 | |
| | | Sharpness | 0~31 | |
| | | Gamma | 1.8/2.0/2.2/2.35/ 2.5/Cubic/sRGB | |
| | | Color Management | Primary Color | |
| | | | Hue | |
| | | | Saturation | |
| | | | Gain | |
| | Silence Mode | On | | |
| | | Off | | |
| | Reset Color Settings | Reset | | |
| | | Cancel | | |





| Main Menu | Sub-menu | Menu Option | | |
|-------------------------|-----------------|-----------------------------|---|--|
| POWER MANAGEMENT | Auto Power On | Signal | Disable/Enable | |
| | | CEC | Disable/Enable | |
| | | Direct Power On | Disable/Enable | |
| | Smart Energy | Auto Power Off | Disable/10 min/20 min/30 min | |
| | | Sleep Timer | Disable/30 min/1 hr/2hr/3 hr/4 hr/ 8 hr/12 hr | |
| | | Power Saving | Disable/Enable | |
| | Power On Source | Disable/HDMI 1/HDMI 2/USB C | | |

| Main Menu | Sub-menu | Menu Option | | |
|-----------|--------------------|--|---|--|
| BASIC | Audio Settings | Audio Mode | Music/Speech/Movie | |
| | | Mute | Off/On | |
| | | Audio Volume | 0~20 | |
| | | Power On/Off Ring Tone | Off/On | |
| | | Audio Out | Internal Speaker/ Audio Out/ HDMI eARC | |
| | | HDMI eARC | Auto/LPCM/ Multi-Channel | |
| | Presentation Timer | Timer Period | 1~240 m | |
| | | Timer Display | Always/1 min/2 min/3 min/Never | |
| | | Timer Position | Top-Left/Bottom-Left/ Top-Right/Bottom-Right | |
| | | Timer Counting Direction | Count Down/Count Up | |
| | | Sound Reminder | Off/On | |
| | | Start Counting/Off | | |
| | Pattern | Off | | |
| | | Test Card | | |
| | Blank Timer | Disable/5 min/10 min/15 min/20 min/25 min/30 min | | |
| | Message | Off | | |
| | | On | | |
| | Splash Screen | Black | | |
| | | Blue | | |
| | | ViewSonic | | |





| Main Menu | Sub-menu | Menu Option | | | |
|-----------|-----------------------|--------------------------------|---|--|--|
| ADVANCED | HDR | HDR/HLG | Auto/SDR | | |
| | | EOTF | Low/Mid/High | | |
| | 3D Settings | 3D Format | Auto | | |
| | | | Off | | |
| | | | Frame Sequential | | |
| | | | Frame Packing | | |
| | | | Top-Bottom | | |
| | | | Side-by-Side | | |
| | | 3D Sync Invert | Disable/Invert | | |
| | Save 3D Settings | Yes/No | | | |
| | HDMI Settings | HDMI Format | Auto/RGB/YUV | | |
| | | HDMI Range | Auto/Enhanced/Normal | | |
| | Ultra Fast Input | Inactive | | | |
| | | Active | | | |
| | Light Source Settings | Light Source Mode | Normal/Eco/ Dynamic Black 1/ Dynamic Black 2/Custom | | |
| | | Light Source Power | 20%~100% | | |
| | | Reset Light Source Hours | Reset/Cancel | | |
| | | Light Source Hours Information | Light Source Usage Time | | |
| | | | Normal | | |
| | | | Eco | | |
| | | | Dynamic Black 1 | | |
| | | | Dynamic Black 2 | | |
| | Custom | | | | |
| | Reset Settings | Reset | | | |
| | | Cancel | | | |

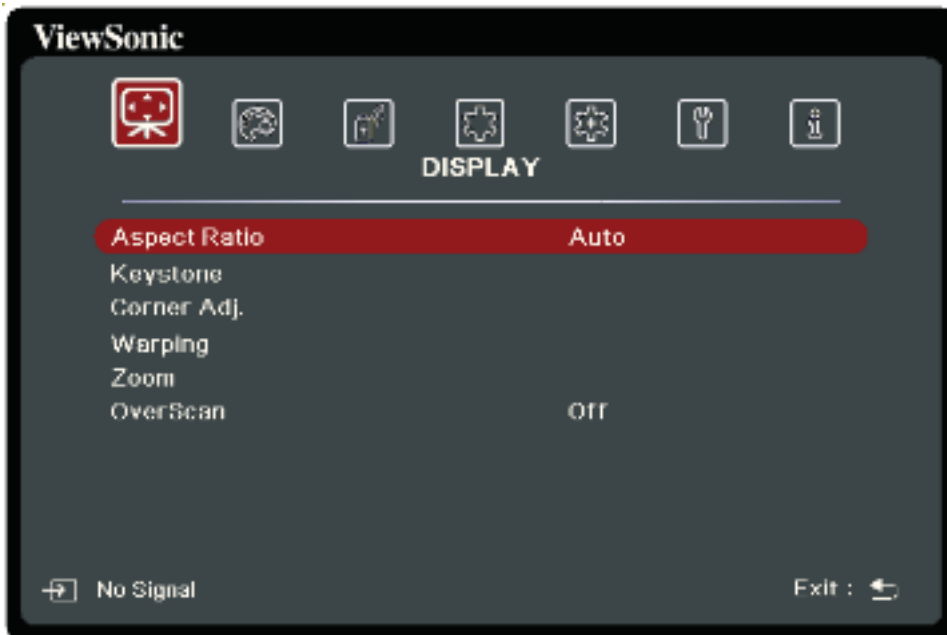

| Main Menu | Sub-menu | Menu Option | | |
|--------------------|---|------------------------------|--|--------|
| SYSTEM | Language | Multi-Language OSD Selection | | |
| | Projector Position | Front Table | | |
| | | Rear Table | | |
| | | Rear Ceiling | | |
| | | Front Ceiling | | |
| | Menu Settings | Menu Display Time | 5 sec/10 sec/15 sec/20 sec/25 sec/30 sec | |
| | | Menu Position | Center/Top-Left/Top-Right/Bottom-Left/Bottom-Right | |
| | High Altitude Mode | Off | | |
| | | On | | |
| | Quick Auto Search | Off | | |
| | | On | | |
| | Security Settings | Change Password | | |
| | | Power On Lock | | Off/On |
| | Panel Key Lock | Off | | |
| | | On | | |
| Control Method | RS232 | | | |
| | Service | | | |
| Baud Rate | 2400/4800/9600/14400/19200/38400/57600/115200 | | | |
| INFORMATION | Source | | | |
| | Color Mode | | | |
| | Resolution | | | |
| | Color System | | | |
| | Firmware Version | | | |
| | Ultra Fast Input | | | |
| | S/N | | | |

DISPLAY Menu

1. Press the **MENU** or  button to display the On-Screen Display (OSD) Menu.
2. Press / to select the **DISPLAY** menu. Then press **ENTER/OK** or use / to access the **DISPLAY** menu.







3. Press / to select the menu option. Then press **ENTER/OK** to display its sub-menu, or press / to adjust/select the setting.

NOTE: Some sub-menu options may have another sub-menu. To enter the respective sub-menu, press **ENTER/OK**. Use / or / to adjust/select the setting.





| Menu Option | Description |
|--------------|--|
| Aspect Ratio | <p><u>Auto</u> Scales an image proportionally to fit the projector's native resolution in its horizontal width. This is suitable for the incoming image which is neither in 4:3 nor 16:9 and you want to make most use of the screen without altering the image's aspect ratio.</p> <p><u>4:3</u> Scales an image so that it is displayed in the center of the screen with a 4:3 aspect ratio. This is most suitable for 4:3 images like computer monitors, standard definition TV, and 4:3 aspect DVD movies, as it displays them without aspect alteration.</p> <p><u>16:9</u> Scales an image so that it is displayed in the center of the screen with a 16:9 aspect ratio. This is most suitable for images which are already in a 16:9 aspect, like high definition TV, as it displays them without aspect alteration.</p> <p><u>16:10</u> Scales an image so that it is displayed in the center of the screen with a 16:10 aspect ratio. This is most suitable for images which are already in a 16:10 aspect, as it displays them without aspect alteration.</p> <p><u>21:9</u> Scales an image so that it is displayed in the center of the screen with a 21:9 aspect ratio without aspect alteration.</p> <p><u>2.35:1</u> Scales an image so that it is displayed in the center of the screen with a 2.35:1 aspect ratio without aspect alteration.</p> <p><u>Native</u> Projects an image as its original resolution and resizes it to fit within the display area. For input signals with lower resolutions, the projected image will be displayed in its original size.</p> |
| Keystone | Adjusts the keystone situation where the projected image becomes a trapezoid due to angled projection. |
| Corner Adj. | Adjusts the shape and size of an image that is unevenly rectangular on all sides. |



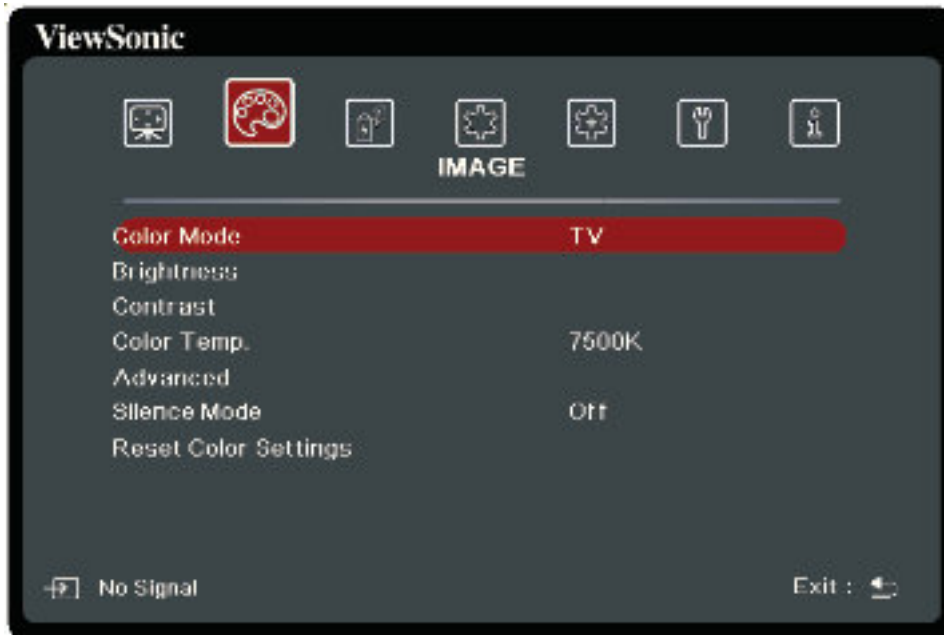

| Menu Option | Description |
|-------------|---|
| Warping | <p>The function is to configure the geometric distortion of the projector's images when the images are projected onto screens which have a kind of uneven surface such as a cylinder, a spherical shape, etc.</p> <p><u>Enable</u> Keystone and Corner Adj. will not be available when Warping is enabled.</p> <p><u>Control Method</u> Allows you to select a preferred control method for warping adjustment.</p> <p><u>Warping Adj.</u> This function is available when On is selected in the Warping > Enable menu and OSD is selected in the Warping > Control Method menu.</p> <ol style="list-style-type: none"> 1. Use ▲/▼/◀/▶ to move the cursor to the point you wish to adjust. 2. Press Enter to enter adjustment mode. 3. Use ▲/▼/◀/▶ to shift the point by x and y coordinates. 4. Press MENU to exit adjustment mode. 5. Repeat step 1 to 4 to adjust another point until you are satisfied with the projected image. 6. Press MENU/Exit to exit the function. <p><u>Reset</u> Returns settings in the Warping menu to the factory preset values.</p> |
| Zoom | Magnifies the projected image and allows you to navigate the image. |
| OverScan | Adjusts the overscan rate from 0 to 5. |







IMAGE Menu

1. Press the **MENU** or  button to display the On-Screen Display (OSD) Menu.
2. Press / to select the **IMAGE** menu. Then press **ENTER/OK** or use / to access the **IMAGE** menu.







3. Press / to select the menu option. Then press **ENTER/OK** to display its sub-menu, or press / to adjust/select the setting.

NOTE: Some sub-menu options may have another sub-menu. To enter the respective sub-menu, press **ENTER/OK**. Use / or / to adjust/select the setting.





| Menu Option | Description |
|-------------|---|
| Color Mode | <p><u>Brightest</u> Maximizes the brightness of the projected image. This mode is suitable for environments where extra-high brightness is required, such as using the projector in well lit rooms.</p> <p><u>TV</u> Optimized for viewing sports in well-lit environments.</p> <p><u>Gaming</u> Suitable for playing video games in a bright living room.</p> <p><u>Movie</u> For playing colorful movies, video clips from digital cameras or DVs through the PC input for best viewing in a blackened (little light) environment.</p> <p><u>Golf</u> This mode is tailored for golf simulators, enhancing the blue sky and vibrant green grass colors.</p> <p><u>Low Blue Light</u> Reduces the emission of harmful low-blue light that is harmful to human's eyesight.</p> <p><u>User</u> Recalls the customized settings. After User/Low Blue Light is selected, some of the sub-menus under the IMAGE menu can be adjusted, according to your selected input source.</p> |
| Brightness | <p>The higher the value, the brighter the image. Adjust this option so the black areas of the image appear just as black and details in the dark area are more visible.</p> <div style="display: flex; justify-content: space-around; align-items: flex-end;">    </div> <div style="display: flex; justify-content: space-around; align-items: center; margin-top: 5px;"> <div style="text-align: center;">-30</div> <div style="text-align: center;">50</div> <div style="text-align: center;">+80</div> </div> |
| Contrast | <p>Use this to set the peak white level after you have previously adjusted the Brightness setting.</p> <div style="display: flex; justify-content: space-around; align-items: flex-end;">    </div> <div style="display: flex; justify-content: space-around; align-items: center; margin-top: 5px;"> <div style="text-align: center;">-30</div> <div style="text-align: center;">0</div> <div style="text-align: center;">+40</div> </div> |



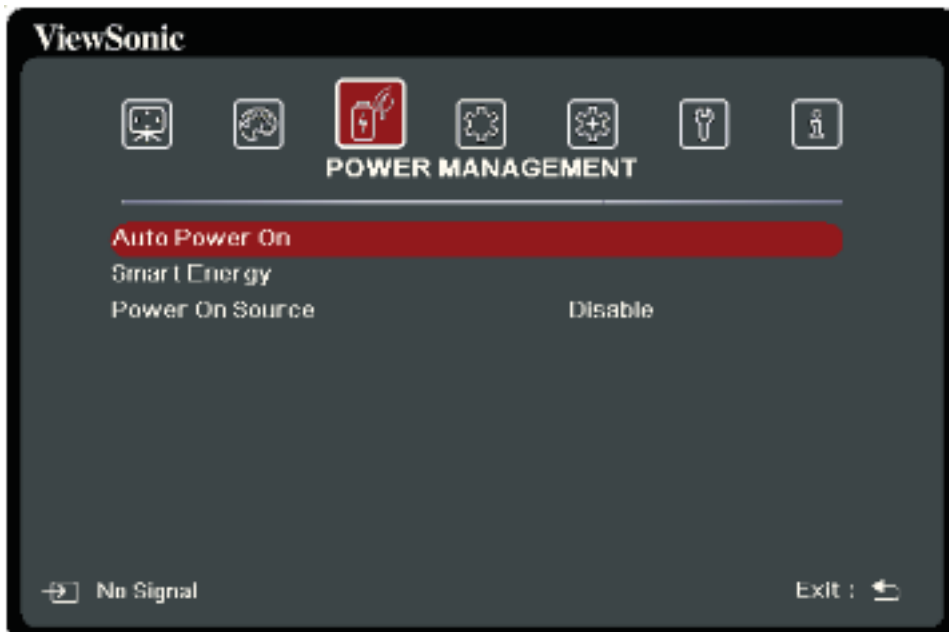

| Menu Option | Description |
|----------------------|--|
| Color Temp. | <p>There are several preset color temperature settings (<u>9300K</u>, <u>7500K</u>, <u>6500K</u>) available. The available settings may vary according to the personal preferences.</p> <p>To set a custom color temperature, you can further adjust the following items:</p> <p><u>Red Gain/Green Gain/Blue Gain</u> Adjusts the Contrast levels of Red, Green, and Blue.</p> <p><u>Red Offset/Green Offset/Blue Offset</u> Adjusts the Brightness levels of Red, Green, and Blue.</p> |
| Advanced | <p><u>Color</u> A lower setting produces less saturated colors. If the setting is too high, colors will be overpowering and may appear unrealistic.</p> <p><u>Sharpness</u> A higher value will sharpen the image, while a lower value will soften the image.</p> <p><u>Gamma</u> Gamma refers to the brightness level of the projector's grayscale levels.</p> <p><u>Color Management</u> Only in permanent installations with controlled lighting levels such as boardrooms, lecture theaters, or home theaters, should color management be considered. Color management provides fine color control adjustment to allow for more accurate color reproduction. Select Primary Color first and adjust its range/values in Hue, Saturation and Gain.</p> |
| Silence Mode | <p>Minimizes the acoustic noise. It is suitable for the need of watching movies that requires an ultra-quiet environment so that you won't be disturbed by the noise of the projector. When this mode is selected, XPR will be off (the projected image will be switched to 1080p resolution automatically).</p> |
| Reset Color Settings | <p>Returns current image settings to the factory preset values.</p> |

POWER MANAGEMENT Menu

1. Press the **MENU** or  button to display the On-Screen Display (OSD) Menu.
2. Press / to select the **POWER MANAGEMENT** menu. Then press **ENTER/OK** or use / to access the **POWER MANAGEMENT** menu.







3. Press / to select the menu option. Then press **ENTER/OK** to display its sub-menu, or press / to adjust/select the setting.





NOTE: Some sub-menu options may have another sub-menu. To enter the respective sub-menu, press **ENTER/OK**. Use / or / to adjust/select the setting.

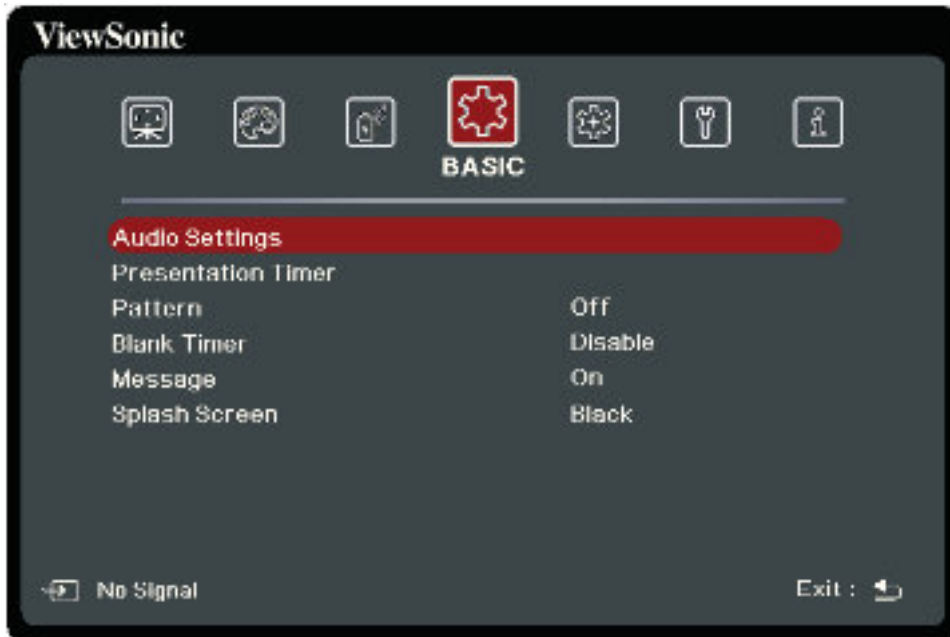

| Menu Option | Description |
|-----------------|--|
| Auto Power On | <p><u>Signal</u> Selecting HDMI allows the projector to turn on automatically once the HDMI/USB C signal is fed through the HDMI/USB C cable.</p> <p><u>CEC</u> This projector supports CEC (Consumer Electronics Control) function for synchronized power on/off operation via HDMI connection. That is, if a device that also supports CEC function is connected to the HDMI input of the projector, when the projector's power is turned off, the power of the connected device will also be turned off automatically. When the power of the connected device is turned on, the projector's power will be turned on automatically.</p> <p>NOTE:</p> <ul style="list-style-type: none"> • In order for the CEC function to work properly, make sure that the device is correctly connected to the HDMI input of the projector via an HDMI cable, and its CEC function is turned on. • Depending on the connected device, the CEC function may not work. <p><u>Direct Power On</u> Allows the projector to turn on automatically once power is fed through the power cord.</p> |
| Smart Energy | <p><u>Auto Power Off</u> Allows the projector to turn off automatically after a set period of time once no input source is detected to prevent unnecessary waste of light source life.</p> <p><u>Sleep Timer</u> Allows the projector to turn off automatically after a set period of time to prevent unnecessary waste of light source life.</p> <p><u>Power Saving</u> Lowers power consumption if no input source is detected. When Enable is selected, the projector light source mode will change to SuperEco mode after no signal is detected for five (5) minutes. This will also help prevent any unnecessary waste of light source life.</p> |
| Power On Source | Enters the desired input source directly after turning on the projector. |

BASIC Menu

1. Press the **MENU** or  button to display the On-Screen Display (OSD) Menu.
2. Press / to select the **BASIC** menu. Then press **ENTER/OK** or use / to access the **BASIC** menu.







3. Press / to select the menu option. Then press **ENTER/OK** to display its sub-menu, or press / to adjust/select the setting.

NOTE: Some sub-menu options may have another sub-menu. To enter the respective sub-menu, press **ENTER/OK**. Use / or / to adjust/select the setting.







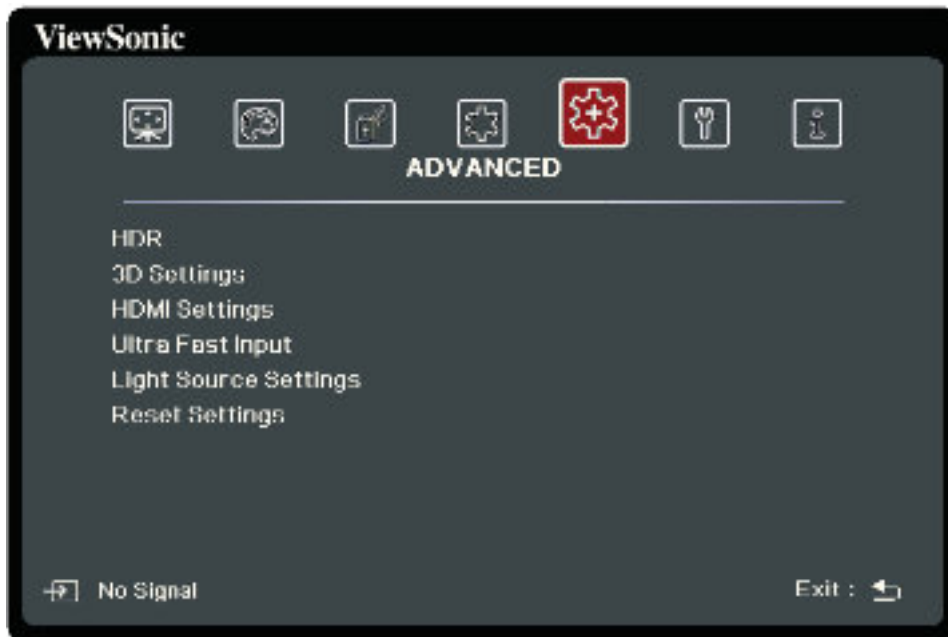

| Menu Option | Description |
|----------------|--|
| Audio Settings | <p><u>Audio Mode</u> Select a preferred audio mode to suit your audio content.</p> <p><u>Mute</u> Select On to temporarily turn off the projector's internal speaker or the volume being output from the audio output jack.</p> <p><u>Audio Volume</u> Adjusts the volume level of the projector's internal speaker or the volume being output from the audio output jack.</p> <p><u>Power On/Off Ring Tone</u> Turns on/off the ring tone during the starting up and shutting down process.</p> <p><u>Audio Out</u> Select an audio output method from built-in speakers (Internal Speaker), the audio output jack (Audio Out), or the HDMI 2 port (HDMI eARC).</p> <p><u>HDMI eARC</u> Adjusts the audio output formats to achieve different audio performance.</p> <ul style="list-style-type: none"> ^m Auto: Automatically adjusts the audio return format. ^m LPCM: Supports 2 channel audio output. ^m Multi-Channel: Supports 5.1 and 7.1 channel audio output. |

| Menu Option | Description |
|--------------------|---|
| Presentation Timer | <p>Presentation timer can indicate the presentation time on the screen to help you achieve better time management when giving presentations.</p> <p><u>Timer Period</u> Sets the time period. If the timer is already on, the timer will restart whenever the Timer Period is reset.</p> <p><u>Timer Display</u> Allows you to decide if you want the timer to show up on the screen for one of the following time periods:</p> <ul style="list-style-type: none"> ^m Always: Displays the timer on screen throughout the presentation time. ^m 1 min/2 min/3 min: Displays the timer on screen in the last 1/2/3 minute(s). ^m Never: Hides the timer throughout the presentation time. <p><u>Timer Position</u> Sets the timer position.</p> <p><u>Timer Counting Direction</u> Sets your desired counting direction between:</p> <ul style="list-style-type: none"> ^m Count Down: Decreases from the preset time to 0. ^m Count Up: Increases from 0 to the preset time. <p><u>Sound Reminder</u> Allows you to decide if you want to activate a sound reminder. Once enabled, a double beep sound will be heard at the last 30 seconds of counting down/up, and a triple beep sound will be produced when the timer is up.</p> <p><u>Start Counting/Off</u> Select Start Counting to activate the timer. Select Off to cancel it.</p> |
| Pattern | Helps adjust the image size and focus, and checks for distortion in the projected image. |
| Blank Timer | <p>Allows the projector to return the image automatically after a period of time when there is no action taken on the blank screen. To display the blank screen, press Blank on the projector.</p> <p>NOTE: Do not block the projection lens as this could cause the blocking object to become heated and deformed or even cause a fire.</p> |
| Message | Sets reminder messages On or Off. |
| Splash Screen | Selects which logo screen will appear during projector start-up. |

ADVANCED Menu

1. Press the **MENU** or  button to display the On-Screen Display (OSD) Menu.
2. Press / to select the **ADVANCED** menu. Then press **ENTER/OK** or use / to access the **ADVANCED** menu.







3. Press / to select the menu option. Then press **ENTER/OK** to display its sub-menu, or press / to adjust/select the setting.
NOTE: Some sub-menu options may have another sub-menu. To enter the respective sub-menu, press **ENTER/OK**. Use / or / to adjust/select the setting.

| Menu Option | Description |
|-------------|---|
| HDR | <p><u>HDR/HLG</u> The projector supports HDR imaging sources. It can automatically detect the dynamic range of the source, and optimize image gamma and color settings to reproduce contents under wide range of light conditions. You also select SDR.</p> <p><u>EOTF</u> The projector can automatically adjust the brightness levels of your image according to the input source. Normally, the default setting “Mid” is recommended. If the brightness of the projected image is dark, please use “Low”. When giving priority to gradation property, please use “High”.</p> |
| 3D Settings | <p>This projector features a 3D function which enables you to enjoy 3D movies, videos, and sporting events in a more realistic way by presenting the depth of the images. You need to wear a pair of 3D glasses to view 3D images.</p> <p><u>3D Format</u> The default setting is Auto and the projector automatically chooses an appropriate 3D format when detecting 3D contents. If the projector cannot recognize the 3D format, choose a 3D mode.</p> <p><u>3D Sync Invert</u> When you discover the inversion of the image depth, enable this function to correct the problem.</p> <p><u>Save 3D Settings</u> Saves current 3D settings. 3D settings will automatically be applied if the same resolution and input source are selected.</p> <p>NOTE: When the 3D Sync function is on:</p> <ul style="list-style-type: none"> • The brightness level of the projected image will decrease. • The Color Mode, Light Source Mode, Zoom, and OverScan cannot be adjusted. |





| Menu Option | Description |
|------------------|---|
| HDMI Settings | <p><u>HDMI Format</u> Select a suitable color space according to the color space setting of the output device connected.</p> <ul style="list-style-type: none"> ^m Auto: Sets the projector to detect the color space setting of the input signal automatically. ^m RGB: Sets the color space as RGB. ^m YUV: Sets the color space as YUV. <p><u>HDMI Range</u> Select a suitable HDMI color range according to the color range setting of the output device connected.</p> <ul style="list-style-type: none"> ^m Auto: Sets the projector to detect the HDMI range of the input signal automatically. ^m Enhanced: Sets the HDMI color range as 0 - 255. ^m Normal: Sets the HDMI color range as 16 - 235. |
| Ultra Fast Input | <p>This function is favorable to frame rate reducing. Quick response time in native timing can be achieved. When enabled, the following settings (if applicable) will return to factory preset values: Warping, Keystone, Corner Adj., Zoom.</p> <p>NOTE: This function is only available when a 1440p@120Hz, 4K@60Hz or 1080P@60/120/240Hz input signal is selected.</p> |



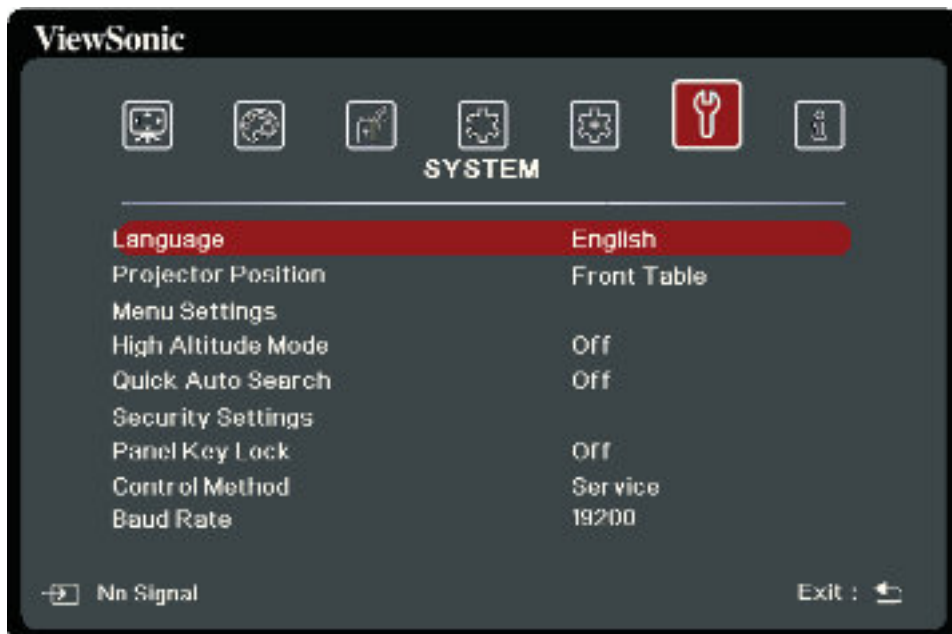

| Menu Option | Description |
|-----------------------|---|
| Light Source Settings | <p><u>Light Source Mode</u></p> <ul style="list-style-type: none"> ^m Normal: Provides full light source brightness. ^m Eco: Reduces light source power consumption by 40% and lowers brightness to extend the light source life and decreases the fan noise. ^m Dynamic Black 1: Reduces light source power consumption by up to 70% depending on the content brightness level. ^m Dynamic Black 2: Reduces light source power consumption by up to 50% depending on the content brightness level. ^m Custom: Allows you to adjust the light source power. <p><u>Light Source Power</u> Only available when Light Source Mode is Custom.</p> <p><u>Reset Light Source Hours</u> Resets the light source timer after a new light source is installed. For changing the light source, please contact qualified service personnel.</p> <p><u>Light Source Hours Information</u></p> <ul style="list-style-type: none"> ^m Light Source Usage Time: Displays the number of hours the light source has been used. |
| Reset Settings | Returns all settings to the factory preset values. When using Reset Settings, the following settings will still remain: Zoom, Keystone, Language, Projector Position, High Altitude Mode, Security Settings, Control Method, Baud Rate and SMART SYSTEM. |

SYSTEM Menu

1. Press the **MENU** or  button to display the On-Screen Display (OSD) Menu.
2. Press / to select the **SYSTEM** menu. Then press **ENTER/OK** or use / to access the **SYSTEM** menu.





3. Press / to select the menu option. Then press **ENTER/OK** to display its sub-menu, or press / to adjust/select the setting.

NOTE: Some sub-menu options may have another sub-menu. To enter the respective sub-menu, press **ENTER/OK**. Use / or / to adjust/select the setting.

| Menu Option | Description |
|--------------------|--|
| Language | Sets the language for the On-Screen Display (OSD) Menu. |
| Projector Position | Selects a proper position for the projector. |
| Menu Settings | <p><u>Menu Display Time</u> Sets the length of time the OSD Menu will remain active after your last interaction.</p> <p><u>Menu Position</u> Sets the OSD Menu's position.</p> |
| High Altitude Mode | <p>We recommend you use the High Altitude Mode when your environment is between 1,500 m to 3,000 m above sea level, and ambient temperature is between 0°C–30°C.</p> <p>NOTE:</p> <ul style="list-style-type: none"> • Do not use High Altitude Mode if your environment is between 0 to 1,499 m, and the temperature is between 0°C to 35°C. If used, the projector will become over cooled. • Using “High Altitude Mode” may cause more operating noise, as the fan speed will be increased to improve cooling and performance. |
| Quick Auto Search | Allows the projector to automatically search for the signals. |
| Security Settings | See “Using the Password Function” on page 17. |
| Panel Key Lock | Locks the control keys on the projector. |
| Control Method | <p>Allows you to select a preferred control port: through the RS232 port or the USB port (Service).</p> <p>NOTE: When Service is selected, the USB power out function will be disabled.</p> |
| Baud Rate | Selects a baud rate that is identical with your computer's so that you can connect the projector using a suitable RS-232 cable and control the projector with RS-232 commands |

INFORMATION Menu

1. Press the **MENU** or  button to display the On-Screen Display (OSD) Menu.
2. Press  /  to select the **INFORMATION** menu and display its contents.

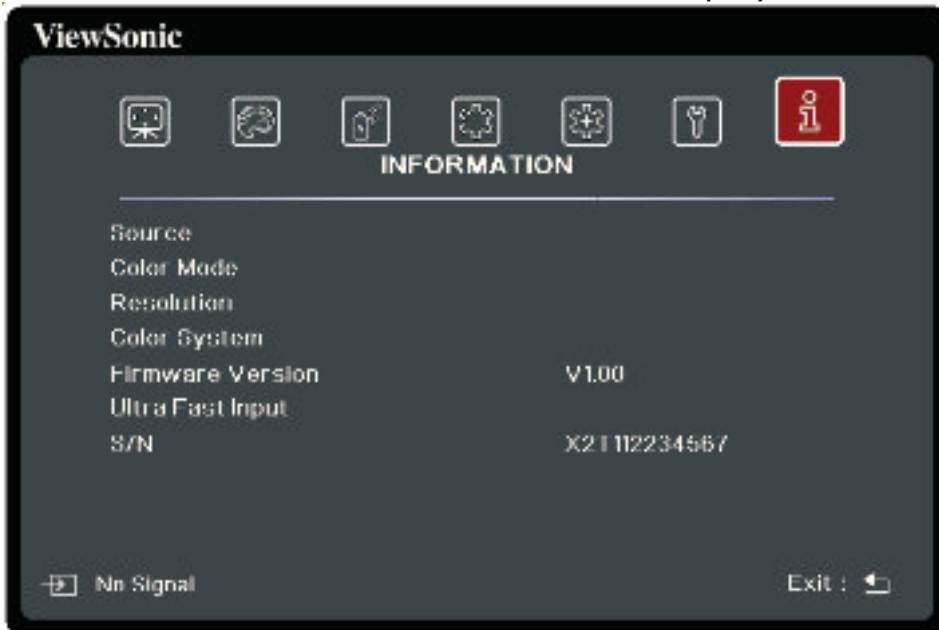

| Menu Option | Description |
|------------------|--|
| Source | Shows the current input source. |
| Color Mode | Shows the selected mode in the IMAGE menu. |
| Resolution | Shows the native resolution of the input source. |
| Color System | Shows input system format. |
| Firmware Version | Shows the current firmware version. |
| Ultra Fast Input | Shows whether the function is activated or not. |
| S/N | Shows the serial number for this projector. |

Smart System

This section will introduce the **Smart System**.

Home Screen

The **Home Screen** is displayed every time you start the projector. To navigate the **Home Screen**, simply use the directional buttons on the remote control. You can return to the main **Home Screen** at any time by pressing the **Home** button on the remote control, regardless of what page you are on.

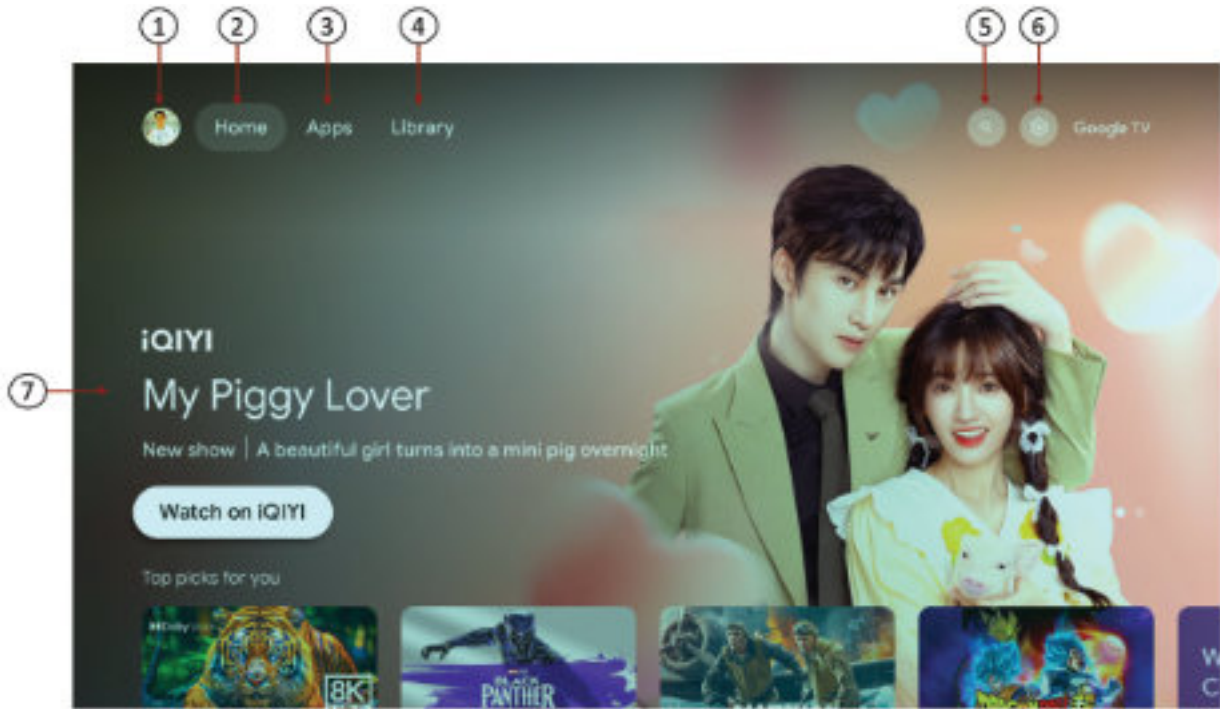

NOTE: The Google TV home screen depends on where you live and the language you choose for your device. For more information, visit <https://support.google.com/googletv/>.

| No. | Item | Description |
|-----|---------------------|---|
| 1. | Account | Access to switch account |
| 2. | Home | Access to Google TV Home screen |
| 3. | Apps | Access to all the installed apps and Google Play |
| 4. | Library | Access to show already on your watchlist |
| 5. | Search | Access to looking for on Google TV, or to discover more content |
| 6. | Settings | Access to Google TV settings menus |
| 7. | Recommended content | Access to the content recommended by the specified channel/streaming service. |

Connect Bluetooth Speaker

You can connect Bluetooth devices, like headphones or soundbar, to your **Smart System**. You can only connect one audio device at a time.



1. From the **Smart System** home screen, in the top right, go to the profile picture or initial and select **Settings**.
2. Select **Remote & Accessories > Pair remote or accessory**.
3. Make sure your device is in pairing mode or is visible to other devices.
4. Identify the device you want to pair from the list and select it.
5. On the Bluetooth pairing request screen, select **Pair**.

Tip: Accessories that have been paired with your device appear in the **Remote & Accessories** of **Settings**. You can also rename or forget devices.

NOTE: The **Bluetooth** function is only available when the input source is **Smart System**. It is not available for the HDMI/USB C source.

Cast

You can cast content from phones, tablets, or laptops to your projector.

1. Connect your device to the same Wi-Fi network as your projector.
2. Open the app that has the content you want to cast.
3. In the app, find and select Cast .
4. On your device, select the name of your projector.
5. When Cast  changes color, you're successfully connected.

To stop casting, on your device, select Cast  > **Disconnect**.

NOTE: You can only cast from the latest version of a Chromecast-enabled app or a Chrome browser on a device connected to the same Wi-Fi network as your projector.

NOTE: The **Cast** function is only available when the input source is **Smart System**. It is not available for the HDMI/USB C source.

Screen Mirroring

Mirror your personal device's screen.

For Android:

1. Download and install the "Google Home" application and open it.
2. Pull-to-refresh the app and wait for 30 seconds.
3. "Devices Name" will now be visible, select it.

For iOS:

iOS devices need to use third-party apps for this. e.g.: AirScreen, AirDroidCast TV.

NOTE: The **Screen Mirroring** function is only available when the input source is **Smart System**. It is not available for the HDMI/USB C source.

Check for system updates

- 1.** From the **Smart System** home screen, at the top right, go to the profile icon.
- 2.** Select **Settings**.
- 3.** Select **System > About > System update**.
- 4.** If an update is available, follow the on-screen instructions to install it.

Appendix

Specifications

| Item | Category | Specifications | |
|----------------------------|----------------------|--|---|
| | | X1-4K Pro | X2-4K Pro |
| Projector | Type | 0.65" 4K UHD, LED | |
| | Display Size | 60"~150" | 60"~120" |
| | Throw Ratio | 1.15~1.5 (95"±3%@2.41m) | 0.69~0.83 (95"±3%@1.44m) |
| | Lens | F = 2.48 – 2.78 | F = 2.53 – 2.73 |
| | Optical Zoom | 1.3x±3% | 1.2x±3% |
| | Light Source Type | LED | |
| | Display System | 1-CHIP DMD | |
| Input signal | HDMI | f _h : 15K~135KHz, f _v :23~240Hz, Max. pixel rate: 600MHz | |
| Resolution | Native | 3840 x 2160 | |
| Power adapter ¹ | Input Voltage | AC 100-240V, 50/60 Hz (auto switch) | |
| Operating conditions | Temperature | 0°C to 40°C (32°F to 104°F) | |
| | Humidity | 10% to 90% (non-condensing) | |
| | Altitude | 0 to 1,499 m at 0°C to 35°C 1,500 to 3,000 m at 0°C to 30°C | |
| Storage conditions | Temperature | -20°C to 60°C (non-condensing) | |
| | Humidity | 10% to 90% (non-condensing) | |
| | Altitude | 0 to 12,200 m at 30°C | |
| Dimensions | Physical (W x H x D) | 355 x 121 x 244 mm (14" x 4.8" x 9.6") | 355 x 121 x 251 mm (14" x 4.8" x 9.9") |
| Weight | Physical | X1-4K Pro: 3.68 ± 0.2 kg (8.11 ± 0.44 lbs) X2-4K Pro: 3.74 ± 0.2 kg (8.25 ± 0.44 lbs) | |
| Power consumption | On ² | 250 W (Typical) | |
| | Off | < 0.5W (Standby) | |

¹ Please use the power adapter from ViewSonic® or an authorized source only.

² The test condition follows EEI standards.

Projector Dimensions

X1-4K Pro

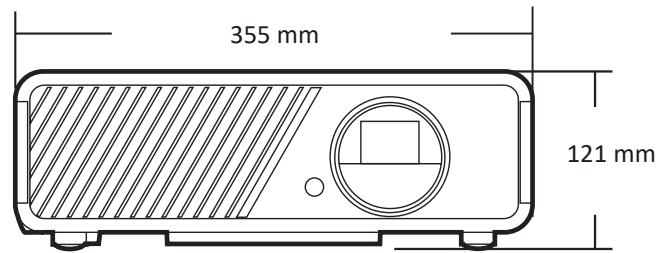
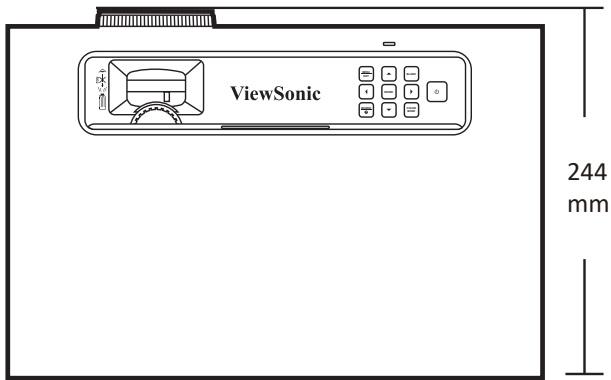

X2-4K Pro

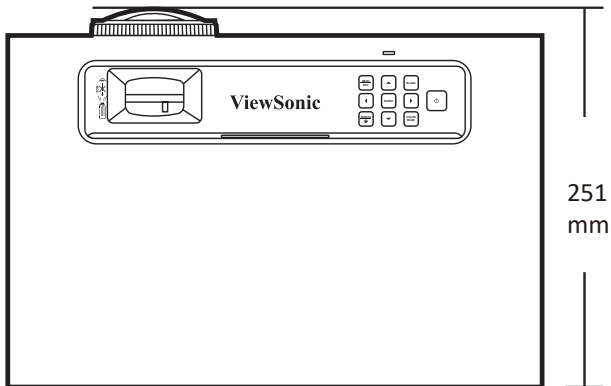

Timing Chart

| HDMI/USB C (PC) | | | |
|-----------------|-------------------|--------------|-------------------|
| Signal | Resolution (dots) | Aspect ratio | Refresh rate (Hz) |
| VGA | 640 x 480 | 4:3 | 60/72/75 |
| SVGA | 800 x 600 | 4:3 | 60/72/75/120 |
| XGA | 1024 x 768 | 4:3 | 60/70/75/120 |
| | 1152 x 864 | 4:3 | 75 |
| HD | 1280x 720 | 16:9 | 60/120 |
| WXGA | 1280 x 768 | 15:9 | 60 |
| | 1280 x 800 | 16:10 | 60/75/120 |
| | 1366 x 768 | 16:9 | 59.7 |
| Quad-VGA | 1280 x 960 | 4:3 | 60 |
| SXGA | 1280 x 1024 | 5:4 | 60/75 |
| SXGA+ | 1400 x 1050 | 4:3 | 60 |
| WXGA+ | 1440 x 900 | 16:10 | 60 |
| UXGA | 1600 x 1200 | 4:3 | 60 |
| WSXGA+ | 1680 x 1050 | 16:10 | 60 |
| WUXGA | 1920 x 1200 | 16:10 | 60 |
| MAC 13" | 640 x 480 | 4:3 | 67 |
| MAC 16" | 832 x 624 | 4:3 | 75 |
| MAC 19" | 1024 x 768 | 4:3 | 75 |
| MAC 21" | 1152 x 870 | 4:3 | 75 |
| HDTV (1080p) | 1920 x 1080 | 16:9 | 60/120/240 |
| | 2560 x 1080 | 21:9 | 60 |
| | 2560 x 1440 | 16:9 | 120 |
| 4K UHD | 3840 x 2160 | 16:9 | 30/60 |

| HDMI/USB C (Video) | | | |
|--------------------|-------------------|--------------|-------------------|
| Signal | Resolution (dots) | Aspect ratio | Refresh rate (Hz) |
| HDTV (4K) | 3840 x 2160 | 16:9 | 24/25/30/50/60 |
| HDTV (1080p) | 1920 x 1080 | 16:9 | 24 |
| HDTV (1080p) | 1920 x 1080 | 16:9 | 50/60 |
| HDTV (1080i) | 1920 x 1080 | 16:9 | 50/60 |
| HDTV (720p) | 1280 x 720 | 16:9 | 50/60 |
| SDTV (480p) | 720 x 480 | 4:3/16:9 | 60 |
| SDTV (576p) | 720 x 576 | 4:3/16:9 | 50 |
| SDTV (480i) | 720 x 480 | 4:3/16:9 | 60 |

| HDMI/USB C (Video) | | | |
|--------------------|-------------------|--------------|-------------------|
| Signal | Resolution (dots) | Aspect ratio | Refresh rate (Hz) |
| SDTV (576i) | 720 x 576 | 4:3/16:9 | 50 |

| 3D (HDMI signal included) | | | |
|---------------------------|-------------------|--------------|-------------------|
| Signal | Resolution (dots) | Aspect ratio | Refresh rate (Hz) |
| Signal | Resolution (dots) | Aspect Ratio | Refresh Rate (Hz) |
| SVGA | 800 x 600 | 4:3 | 60*/120** |
| XGA | 1024 x 768 | 4:3 | 60*/120** |
| HD | 1280 x 720 | 16:9 | 60*/120** |
| WXGA | 1280 x 800 | 16:9 | 60*/120** |
| HDTV (1080p) | 1920 x 1080 | 16:9 | 60* |

NOTE: *60Hz signals are supported for Side-by-Side, Top-Bottom, and Frame Sequential formats.

NOTE: **120 Hz signals are supported for Frame Sequential format only.

| HDMI 3D | | | |
|--------------------------------|-------------------|--------------|-------------------|
| Signal | Resolution (dots) | Aspect ratio | Refresh rate (Hz) |
| In Frame Packing format | | | |
| 1080p | 1920 x 1080 | 16:9 | 23.98/24 |
| 720p | 1280 x 720 | 16:9 | 50/59.94/60 |
| In Side-by-Side format | | | |
| 1080i | 1920 x 1080 | 16:09 | 50/60 |
| 1080p | 1920 x 1080 | 16:09 | 50/60 |
| In Top-Bottom format | | | |
| 1080p | 1920 x 1080 | 16:9 | 24/50/60 |
| 720p | 1280 x 720 | 16:9 | 50/60 |
| 576p | 720 x 576 | 16:9 | 60 |
| 480p | 720 x 480 | 16:9 | 59.94 |

Troubleshooting

Common Problems

This section describes some common problems that you may experience when using the projector.

| Problem | Possible Solutions |
|----------------------------------|--|
| The projector does not turn on | <ul style="list-style-type: none">• Ensure the power cord is properly attached to the projector and to the power outlet.• If the cooling process has not completed, please wait until it has finished then try to turn on the projector again.• If the above does not work, try another power outlet or another electrical device with the same power outlet. |
| There is no picture | <ul style="list-style-type: none">• Ensure the video source cable is connected properly, and that the video source is turned on.• If the input source is not selected automatically, select the correct source with the Source key on either the projector or the remote control. |
| The image is blurred | <ul style="list-style-type: none">• Adjusting the Focus Ring will help correctly focus the projection lens.• Ensure the projector and screen are aligned properly. If necessary, adjust the height of the projector as well as the projection angle and direction. |
| The remote control does not work | <ul style="list-style-type: none">• Ensure there are no obstacles between the remote control and projector; and that they are within 8 m (26 ft) of each other.• The batteries may be out of power, please check and replace if necessary.• The voice function is not available when the remote control is not paired in the Smart System, or when there is no Internet connection. |
| The image abnormal | <ul style="list-style-type: none">• Ensure the video source cable is connected properly, and that the video source is turned on.• If the above does not work, check the air intake or exhaust not block. |

LED Indicator

| Light | Status and Description |
|----------------------------------|-------------------------------|
| Orange | Stand-by mode |
| Green Flashing | Powering up |
| Green | Normal operation |
| Red | Downloading |
| Orange Flashing | Burn in off |
| Red Flashing once per second | Fan error |
| Red Flashing once per 3 seconds | Thermal and temperature error |
| Green & Red Flashing alternately | Light source error |

Maintenance

General Precautions

- Make sure the Projector is turned off and the power cable is unplugged from the power outlet.
- Never remove any parts from the Projector. Contact ViewSonic® or a reseller when any part of the Projector needs replacing.
- Never spray or pour any liquid directly onto the case.
- Handle the Projector with care, as a darker-colored projector, if scuffed, may show marks more clearly than a lighter-colored projector.

Cleaning the Lens

- Use a canister of compressed air to remove dust.
- If the lens is still not clean, use lens-cleaning paper or moisten a soft cloth with lens cleaner and gently wipe the surface.

CAUTION: Never rub the lens with abrasive materials.

Cleaning the Case

- Use a soft, lint-free, dry cloth to remove dirt or dust.
- If the case is still not clean, apply a small amount of non-ammonia, non-alcohol based, mild non-abrasive detergent onto a clean, soft, lint-free cloth, then wipe the surface.

CAUTION: Never use wax, alcohol, benzene, thinner, or other chemical detergents.

Storing the Projector

If you intend to store the Projector for an extended period of time:

- Ensure the temperature and humidity of the storage area are within the recommend range.
- Retract the adjuster foot completely.
- Remove the batteries from the Remote Control.
- Pack the Projector in its original packaging or equivalent.

Disclaimer

- ViewSonic® does not recommend the use of any ammonia or alcohol-based cleaners on the lens or case. Some chemical cleaners have been reported to damage the lens and/or case of the projector.
- ViewSonic® will not be liable for damage resulting from use of any ammonia or alcohol-based cleaners.

Regulatory and Service Information

Compliance Information

This section addresses all connected requirements and statements regarding regulations. Confirmed corresponding applications shall refer to nameplate labels and relevant markings on the unit.

FCC Compliance Statement

This device complies with part 15 of FCC Rules. Operation is subject to the following two conditions: (1) this device may not cause harmful interference, and (2) this device must accept any interference received, including interference that may cause undesired operation. This equipment has been tested and found to comply with the limits for a Class B digital device, pursuant to part 15 of the FCC Rules.

These limits are designed to provide reasonable protection against harmful interference in a residential installation. This equipment generates, uses, and can radiate radio frequency energy, and if not installed and used in accordance with the instructions, may cause harmful interference to radio communications. However, there is no guarantee that interference will not occur in a particular installation. If this equipment does cause harmful interference to radio or television reception, which can be determined by turning the equipment off and on, the user is encouraged to try to correct the interference by one or more of the following measures:

- Reorient or relocate the receiving antenna.
- Increase the separation between the equipment and receiver.
- Connect the equipment into an outlet on a circuit different from that to which the receiver is connected.
- Consult the dealer or an experienced radio/TV technician for help.

Warning: You are cautioned that changes or modifications not expressly approved by the party responsible for compliance could void your authority to operate the equipment.

Industry Canada Statement

This Class B digital apparatus complies with Canadian ICES-003.

Cet appareil numérique de classe B est conforme à la norme NMB-003 du Canada.

CAN ICES-003(B) / NMB-003(B)

CE Conformity for European Countries

CE The device complies with the EMC Directive 2014/30/EU and Low Voltage Directive 2014/35/EU. Ecodesign Directive 2009/125/EC.

The following information is only for EU-member states:

The mark shown to the right is in compliance with the Waste Electrical and Electronic Equipment Directive 2012/19/EU (WEEE). The mark indicates the requirement NOT to dispose of the equipment as unsorted municipal waste, but use the return and collection systems according to local law.



Declaration of RoHS2 Compliance

This product has been designed and manufactured in compliance with Directive 2011/65/EU of the European Parliament and the Council on restriction of the use of certain hazardous substances in electrical and electronic equipment (RoHS2 Directive) and is deemed to comply with the maximum concentration values issued by the European Technical Adaptation Committee (TAC) as shown below:

| Substance | Proposed Maximum Concentration | Actual Concentration |
|---|--------------------------------|----------------------|
| Lead (Pb) | 0.1% | < 0.1% |
| Mercury (Hg) | 0.1% | < 0.1% |
| Cadmium (Cd) | 0.01% | < 0.01% |
| Hexavalent Chromium (Cr6 ⁺) | 0.1% | < 0.1% |
| Polybrominated biphenyls (PBB) | 0.1% | < 0.1% |
| Polybrominated diphenyl ethers (PBDE) | 0.1% | < 0.1% |
| Bis (2-ethylhexyl) phthalate (DEHP) | 0.1% | < 0.1% |
| Butyl benzyl phthalate (BBP) | 0.1% | < 0.1% |
| Dibutyl phthalate (DBP) | 0.1% | < 0.1% |
| Diisobutyl phthalate (DIBP) | 0.1% | < 0.1% |

Certain components of products as stated above are exempted under the Annex III of the RoHS2 Directives as noted below. Examples of exempted components are:

- Copper alloy containing up to 4% lead by weight.
- Lead in high melting temperature type solders (i.e. lead-based alloys containing 85% by weight or more lead).
- Electrical and electronic components containing lead in a glass or ceramic other than dielectric ceramic in capacitors, e.g. piezoelectronic devices, or in a glass or ceramic matrix compound.
- Lead in dielectric ceramic in capacitors for a rated voltage of 125 V AC or 250 V DC or higher.

Indian Restriction of Hazardous Substances

Restriction on Hazardous Substances statement (India). This product complies with the “India E-waste Rule 2011” and prohibits use of lead, mercury, hexavalent chromium, polybrominated biphenyls or polybrominated diphenyl ethers in concentrations exceeding 0.1 weight % and 0.01 weight % for cadmium, except for the exemptions set in Schedule 2 of the Rule.

Product Disposal at End of Product Life

ViewSonic® respects the environment and is committed to working and living green. Thank you for being part of Smarter, Greener Computing. Please visit the ViewSonic® website to learn more.

USA & Canada:

<https://www.viewsonic.com/us/go-green-with-viewsonic>

Europe:

<https://www.viewsonic.com/eu/environmental-social-governance/recycle>

Taiwan:

<https://recycle.moenv.gov.tw/>

For EU users, please contact us for any safety/accident issue experienced with this product:

ViewSonic Europe Limited



Haaksbergweg 75
1101 BR Amsterdam
Netherlands



+31 (0) 650608655



EPREL@viewsoniceurope.com



<https://www.viewsonic.com/eu/>

Copyright Information

Copyright© ViewSonic® Corporation, 2024. All rights reserved.

Macintosh and Power Macintosh are registered trademarks of Apple Inc.

Microsoft, Windows, and the Windows logo are registered trademarks of Microsoft Corporation in the United States and other countries.

ViewSonic® and the three birds logo are registered trademarks of ViewSonic® Corporation.

VESA is a registered trademark of the Video Electronics Standards Association. DPMS, DisplayPort, and DDC are trademarks of VESA.

ENERGY STAR® is a registered trademark of the U.S. Environmental Protection Agency (EPA).

As an ENERGY STAR® partner, ViewSonic® Corporation has determined that this product meets the ENERGY STAR® guidelines for energy efficiency.

Disclaimer: ViewSonic® Corporation shall not be liable for technical or editorial errors or omissions contained herein; nor for incidental or consequential damages resulting from furnishing this material, or the performance or use of this product.

In the interest of continuing product improvement, ViewSonic® Corporation reserves the right to change product specifications without notice. Information in this document may change without notice.

No part of this document may be copied, reproduced, or transmitted by any means, for any purpose without prior written permission from ViewSonic® Corporation.

Customer Service

For technical support or product service, see the table below or contact your reseller.

NOTE: You will need the product's serial number.

| Country/ Region | Website | Country/ Region | Website |
|----------------------------------|--|--------------------------|--|
| Asia Pacific & Africa | | | |
| Australia | www.viewsonic.com/au/ | Bangladesh | www.viewsonic.com/bd/ |
| 中国 (China) | www.viewsonic.com.cn | 香港 (繁體中文) | www.viewsonic.com/hk/ |
| Hong Kong (English) | www.viewsonic.com/hk-en/ | India | www.viewsonic.com/in/ |
| Indonesia | www.viewsonic.com/id/ | Israel | www.viewsonic.com/il/ |
| 日本 (Japan) | www.viewsonic.com/jp/ | Korea | www.viewsonic.com/kr/ |
| Malaysia | www.viewsonic.com/my/ | Middle East | www.viewsonic.com/me/ |
| Myanmar | www.viewsonic.com/mm/ | Nepal | www.viewsonic.com/np/ |
| New Zealand | www.viewsonic.com/nz/ | Pakistan | www.viewsonic.com/pk/ |
| Philippines | www.viewsonic.com/ph/ | Singapore | www.viewsonic.com/sg/ |
| 臺灣 (Taiwan) | www.viewsonic.com/tw/ | ประเทศไทย | www.viewsonic.com/th/ |
| Việt Nam | www.viewsonic.com/vn/ | South Africa & Mauritius | www.viewsonic.com/za/ |
| Americas | | | |
| United States | www.viewsonic.com/us | Canada | www.viewsonic.com/us |
| Latin America | www.viewsonic.com/la | | |
| Europe | | | |
| Europe | www.viewsonic.com/eu/ | France | www.viewsonic.com/fr/ |
| Deutschland | www.viewsonic.com/de/ | Қазақстан | www.viewsonic.com/kz/ |
| Россия | www.viewsonic.com/ru/ | España | www.viewsonic.com/es/ |
| Türkiye | www.viewsonic.com/tr/ | Україна | www.viewsonic.com/ua/ |
| United Kingdom | www.viewsonic.com/uk/ | | |

Limited Warranty

ViewSonic® Projector

What the warranty covers:

ViewSonic® warrants its products to be free from defects in material and workmanship, under normal use, during the warranty period. If a product proves to be defective in material or workmanship during the warranty period, ViewSonic® will, at its sole option, repair or replace the product with a like product. Replacement product or parts may include remanufactured or refurbished parts or components.

Limited Three (3) year General Warranty:

Subject to the more limited one (1) year warranty set out below, North and South America: Three (3) years warranty for all parts excluding the lamp, three (3) years for labor, and one (1) year for the original lamp from the date of the first consumer purchase.

Other regions or countries: Please check with your local dealer or local ViewSonic® office for the warranty information.

Limited One (1) year Heavy Usage Warranty:

Under heavy usage settings, where a projector's use includes more than fourteen (14) hours average daily usage, North and South America: One (1) year warranty for all parts excluding the lamp, one (1) year for labor, and ninety (90) days for the original lamp from the date of the first consumer purchase; Europe: One (1) year warranty for all parts excluding the lamp, one (1) year for labor, and ninety (90) days for the original lamp from the date of the first consumer purchase. Other regions or countries: Please check with your local dealer or local ViewSonic® office for the warranty information. Lamp warranty subject to terms and conditions, verification and approval. Applies to manufacturer's installed lamp only. All accessory lamps purchased separately are warranted for 90 days.

Who the warranty protects:

This warranty is valid only for the first consumer purchaser.

What the warranty does not cover:

1. Any product on which the serial number has been defaced, modified, or removed.
2. Damage, deterioration, or malfunction resulting from:
 - ^m Accident, misuse, neglect, fire, water, lightning, or other acts of nature, unauthorized product modification, or failure to follow instructions supplied with the product.
 - ^m Operation outside of product specifications.
 - ^m Operation of the product for other than the normal intended use or not under normal conditions.
 - ^m Repair or attempted repair by anyone not authorized by ViewSonic®.
 - ^m Any damage of the product due to shipment.
 - ^m Removal or installation of the product.
 - ^m Causes external to the product, such as electric power fluctuations or failure.
 - ^m Use of supplies or parts not meeting Viewsonic's specifications.
 - ^m Normal wear and tear.
 - ^m Any other cause which does not relate to a product defect.
3. Removal, installation, and set-up service charges.

How to get service:

1. For information about receiving service under warranty, contact ViewSonic® Customer Support (Please refer to the "Customer Support" page). You will need to provide your product's serial number.
2. To obtain warranted service, you will be required to provide: (a) the original dated sales slip, (b) your name, (c) your address, (d) a description of the problem, and (e) the serial number of the product.
3. Take or ship the product, freight prepaid, in the original container to an authorized ViewSonic® service center or ViewSonic®.
4. For additional information or the name of the nearest ViewSonic® service center, contact ViewSonic®.

Limitation of implied warranties:

There are no warranties, express or implied, which extend beyond the description contained herein including the implied warranty of merchantability and fitness for a particular purpose.

Exclusion of damages:

ViewSonic's liability is limited to the cost of repair or replacement of the product. ViewSonic® shall not be liable for:

1. Damage to other property caused by any defects in the product, damages based upon inconvenience, loss of use of the product, loss of time, loss of profits, loss of business opportunity, loss of goodwill, interference with business relationships, or other commercial loss, even if advised of the possibility of such damages.
2. Any other damages, whether incidental, consequential or otherwise.
3. Any claim against the customer by any other party.

Effect of state law:

This warranty gives you specific legal rights, and you may also have other rights which vary from local authority. Some local governments do not allow limitations on implied warranties and/or do not allow the exclusion of incidental or consequential damages, so the above limitations and exclusions may not apply to you.

Sales outside the U.S.A. and Canada:

For warranty information and service on ViewSonic® products sold outside of the U.S.A. and Canada, contact ViewSonic® or your local ViewSonic® dealer.

The warranty period for this product in mainland China (Hong Kong, Macao, and Taiwan Excluded) is subject to the terms and conditions of the Maintenance Guarantee Card.

For users in Europe and Russia, full details of warranty provided can be found at: <http://www.viewsonic.com/eu/> under "Support/Warranty Information".

Mexico Limited Warranty

ViewSonic® Projector

What the warranty covers:

ViewSonic® warrants its products to be free from defects in material and workmanship, under normal use, during the warranty period. If a product proves to be defective in material or workmanship during the warranty period, ViewSonic® will, at its sole option, repair or replace the product with a like product. Replacement product or parts may include remanufactured or refurbished parts or components & accessories.

How long the warranty is effective:

3 years for all parts excluding the lamp, 3 years for labor, 1 year for the original lamp from the date of the first consumer purchase.

Lamp warranty subject to terms and conditions, verification and approval. Applies to manufacturer's installed lamp only.

All accessory lamps purchased separately are warranted for 90 days.

Who the warranty protects:

This warranty is valid only for the first consumer purchaser.

What the warranty excludes and does not cover:

1. Any product on which the serial number has been defaced, modified or removed.
2. Damage, deterioration, or malfunction resulting from:
 - ^m Accident, misuse, neglect, fire, water, lightning, or other acts of nature, unauthorized product modification, unauthorized attempted repair, or failure to follow instructions supplied with the product.
 - ^m Any damage of the product due to shipment.
 - ^m Causes external to the product, such as electrical power fluctuations or failure.
 - ^m Use of supplies or parts not meeting ViewSonic®'s specifications.
 - ^m Normal wear and tear.
 - ^m Any other cause which does not relate to a product defect.
3. Any product exhibiting a condition commonly known as "image burn-in" which results when a static image is displayed on the product for an extended period of time.
4. Removal, installation, insurance, and set-up service charges.

How to get service:

For information about receiving service under warranty, contact ViewSonic® Customer Support (Please refer to the attached “Customer Service” page). You will need to provide your product’s serial number, so please record the product information in the space provided below on your purchase for your future use. Please retain your receipt of proof of purchase to support your warranty claim.

For Your Records

Product Name: _____ Model Number: _____

Document Number: _____ Serial Number: _____

Purchase Date: _____ Extended Warranty Purchase? _____ (Y/N)

If so, what date does warranty expire? _____

1. To obtain warranty service, you will be required to provide (a) the original dated sales slip, (b) your name, (c) your address, (d) a description of the problem, and (e) the serial number of the product.
2. Take or ship the product, in the original container packaging, to an authorized ViewSonic® service center.
3. Round trip transportation costs for in-warranty products will be paid by ViewSonic®.

Limitation of implied warranties:

There are no warranties, express or implied, which extend beyond the description contained herein including the implied warranty of merchantability and fitness for a particular purpose.

Exclusion of damages:

ViewSonic®’s liability is limited to the cost of repair or replacement of the product. ViewSonic® shall not be liable for:

1. Damage to other property caused by any defects in the product, damages based upon inconvenience, loss of use of the product, loss of time, loss of profits, loss of business opportunity, loss of goodwill, interference with business relationships, or other commercial loss, even if advised of the possibility of such damages.
2. Any other damages, whether incidental, consequential or otherwise.
3. Any claim against the customer by any other party.
4. Repair or attempted repair by anyone not authorized by ViewSonic®.

Contact Information for Sales & Authorized Service (Centro Autorizado de Servicio) within Mexico:

Name, address, of manufacturer and importers:

México, Av. de la Palma #8 Piso 2 Despacho 203, Corporativo Interpalmas,
Col. San Fernando Huixquilucan, Estado de México
Tel: (55) 3605-1099 <http://www.viewsonic.com/la/soporte/index.htm>

NÚMERO GRATIS DE ASISTENCIA TÉCNICA PARA TODO MÉXICO: 001.866.823.2004

Hermosillo:

Distribuciones y Servicios Computacionales SA de CV.
Calle Juárez 284 local 2
Col. Bugambilias C.P: 83140
Tel: 01-66-22-14-9005
E-Mail: disc2@hmo.megared.net.mx

Villahermosa:

Compumantenimientos Garantizados, S.A. de C.V.
AV. GREGORIO MENDEZ #1504
COL, FLORIDA C.P. 86040
Tel: 01 (993) 3 52 00 47 / 3522074 / 3 52 20 09
E-Mail: compumantenimientos@prodigy.net.mx

Puebla, Pue. (Matriz):

RENTA Y DATOS, S.A. DE C.V. Domicilio:
29 SUR 721 COL. LA PAZ
72160 PUEBLA, PUE.
Tel: 01(52).222.891.55.77 CON 10 LINEAS
E-Mail: datos@puebla.megared.net.mx

Veracruz, Ver.:

CONEXION Y DESARROLLO, S.A DE C.V. Av.
Americas # 419
ENTRE PINZÓN Y ALVARADO
Fracc. Reforma C.P. 91919
Tel: 01-22-91-00-31-67
E-Mail: gacosta@qplus.com.mx

Chihuahua:

Soluciones Globales en Computación
C. Magisterio # 3321 Col. Magisterial
Chihuahua, Chih.
Tel: 4136954
E-Mail: Cefeo@soluglobales.com

Cuernavaca:

Compusupport de Cuernavaca SA de CV
Francisco Leyva # 178 Col. Miguel Hidalgo
C.P. 62040, Cuernavaca Morelos
Tel: 01 777 3180579 / 01 777 3124014
E-Mail: aquevedo@compusupportcva.com

Distrito Federal:

QPLUS, S.A. de C.V.
Av. Coyoacán 931
Col. Del Valle 03100, México, D.F.
Tel: 01(52)55-50-00-27-35
E-Mail : gacosta@qplus.com.mx

Guadalajara, Jal.:

SERVICRECE, S.A. de C.V.
Av. Niños Héroes # 2281
Col. Arcos Sur, Sector Juárez
44170, Guadalajara, Jalisco
Tel: 01(52)33-36-15-15-43
E-Mail: mmiranda@servicrece.com

Guerrero Acapulco:

GS Computación (Grupo Sesicomp)
Progreso #6-A, Colo Centro
39300 Acapulco, Guerrero
Tel: 744-48-32627

Monterrey:

Global Product Services
Mar Caribe # 1987, Esquina con Golfo Pérsico
Fracc. Bernardo Reyes, CP 64280
Monterrey N.L. México
Tel: 8129-5103
E-Mail: aydeem@gps1.com.mx

MERIDA:

ELECTROSER
Av Reforma No. 403Gx39 y 41
Mérida, Yucatán, México CP97000
Tel: (52) 999-925-1916
E-Mail: rrrb@sureste.com

Oaxaca, Oax.:

CENTRO DE DISTRIBUCION Y
SERVICIO, S.A. de C.V.
Murguía # 708 P.A., Col. Centro, 68000, Oaxaca
Tel: 01(52)95-15-15-22-22
Fax: 01(52)95-15-13-67-00
E-Mail: gpotai2001@hotmail.com

Tijuana:

STD
Av Ferrocarril Sonora #3780 L-C
Col 20 de Noviembre
Tijuana, Mexico

FOR USA SUPPORT:

ViewSonic® Corporation
381 Brea Canyon Road, Walnut, CA. 91789 USA
Tel: 800-688-6688
E-Mail: <http://www.viewsonic.com>



ViewSonic®